



STUDY GUIDE:

**CHEMISTRY**

**SL**

[www.ib.academy](http://www.ib.academy)



# IB Academy Chemistry Study Guide

Available on [learn.ib.academy](https://learn.ib.academy)

Author: Tim van Puffelen

Design

**Rational**

Typesetting



*This work may be shared digitally and in printed form,  
but it may not be changed and then redistributed in any form.*

Copyright © 2020, IB Academy

Version: CheSL.3.0.200227



This work is published under the Creative Commons BY-NC-ND 4.0 International License. To view a copy of this license, visit [creativecommons.org/licenses/by-nc-nd/4.0](https://creativecommons.org/licenses/by-nc-nd/4.0)

This work may not be used for commercial purposes other than by IB Academy, or parties directly licenced by IB Academy. If you acquired this guide by paying for it, or if you have received this guide as part of a paid service or product, directly or indirectly, we kindly ask that you contact us immediately.

Laan van Puntenburg 2a  
3511ER, Utrecht  
The Netherlands

[ib.academy](https://ib.academy)  
[info@ib.academy](mailto:info@ib.academy)  
+31 (0) 30 4300 430

Welcome to the IB.Academy Study Guide for IB Chemistry Standard Level.

We are proud to present our study guides and hope that you will find them helpful. They are the result of a collaborative undertaking between our tutors, students and teachers from schools across the globe. Our mission is to create the most simple yet comprehensive guides accessible to IB students and teachers worldwide. We are firm believers in the open education movement, which advocates for transparency and accessibility of academic material. As a result, we embarked on this journey to create these study guides that will be continuously reviewed and improved. Should you have any comments, feel free to contact us.

For this Chemistry SL guide, we incorporated everything you need to know for your final exam. The guide is broken down into manageable chapters based on the syllabus topics. The chapter is then further divided into subtopics.

For more information and details on our revision courses, be sure to visit our website at [ib.academy](http://ib.academy). We hope that you will enjoy our guides and best of luck with your studies.

IB.Academy Team



# TABLE OF CONTENTS

<b>1. Quantitative chemistry</b>	<b>7</b>
- Types and states of matter - Chemical reactions - Mole concept and chemical calculations	
<b>2. Atomic structure</b>	<b>21</b>
- Types of particles - Notation - Isotopes: abundance and $A_r$ - Atomic shells/subshells/orbitals - Electromagnetic spectrum	
<b>3. Periodicity</b>	<b>31</b>
- The Periodic Table (PT) - Periodic trends	
<b>4. Bonding</b>	<b>37</b>
- Metallic Bonding - Ionic bonding - Covalent bonding - Intermolecular forces - Properties of molecular compounds	
<b>5. Energetics</b>	<b>53</b>
- Temperature vs heat vs enthalpy - Energy diagrams - Hess's law - Energy calculations	
<b>6. Kinetics</b>	<b>65</b>
- Collision Theory	

<b>7. Equilibrium</b>	<b>69</b>
<ul style="list-style-type: none"> <li>- Dynamic equilibrium – Equilibrium law expression</li> <li>- States of matter – Le Chatelier’s principle</li> </ul>	
<b>8. Acids and bases</b>	<b>75</b>
<ul style="list-style-type: none"> <li>- Acid and base definitions – Strong vs weak – pH scale</li> <li>- Acid Deposition</li> </ul>	
<b>9. Redox</b>	<b>81</b>
<ul style="list-style-type: none"> <li>- Oxidation states – Reactions – Reactivity</li> <li>- Electrochemical cells – The Winkler method and the BOD</li> </ul>	
<b>10. Organic chemistry</b>	<b>89</b>
<ul style="list-style-type: none"> <li>- Fundamentals of organic chemistry – Structural isomers</li> <li>- Reactions – Free radical substitution</li> </ul>	
<b>11. Measurement and data processing</b>	<b>103</b>
<ul style="list-style-type: none"> <li>- Graphical Techniques – Spectroscopic identification</li> </ul>	

# QUANTITATIVE CHEMISTRY

1

## 1.1 Types and states of matter

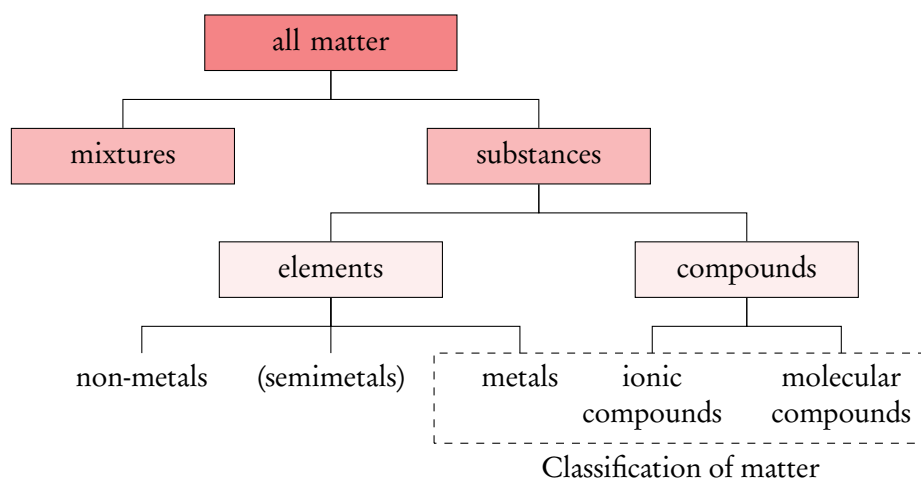

**Substance** has a definite chemical composition and characteristic properties

**Mixture** contains multiple substances that retain their individual properties because they are not chemically bonded, which can be separated using the difference between the individual properties of each substance.

### Homogeneous mixture:

Components are in the same phase, particles are distributed equally over the mixture  
e.g. solution, alloy

### Heterogeneous mixture:

Components are not all in the same phase, there are physical boundaries between the components.  
e.g. suspension, emulsion

Classification of matter:

**metal**

**ionic compound**

**molecular compound**

**type of element(s):**

metal

metal + non-metal

non-metal

**Elements** are atoms that have the same number of protons. **Elemental substances** contain one type of element (e.g., Na, Fe, H<sub>2</sub>, Cl<sub>2</sub>, S<sub>8</sub>, ...)

**Compounds** at least *two different elements* combine to form a compound

The chemical composition of a substance is expressed in a chemical formula, which shows the number of each atom in a substance (e.g. H<sub>2</sub>O), or the ratio of ions in an ionic compound (e.g. MgCl<sub>2</sub>).

Note that for ionic compounds only the empirical formula is used, because ions assemble in a whole number ratio in a lattice, but not as molecules.

	molecular formula	structural formula	empirical formula
example	$C_2H_4$	$  \begin{array}{c}  H & & H \\  & \diagdown & / \\  & C = C & \\  & / & \diagdown \\  H & & H  \end{array}  $	$CH_2$
showing	number of atoms	bonding between the atoms	simplest number ratio of atoms

Example.

Which compound has the empirical formula with the greatest mass?

	molecular formula	divisible by	empirical formula	
A.	$C_2H_6$	2	$CH_3$	
B.	$C_4H_{10}$	2	$C_2H_5$	← greatest mass
C.	$C_5H_{10}$	5	$CH_2$	
D.	$C_6H_6$	6	$CH$	

### Find the empirical formula given weight percentage composition

A compound is found to contain 64.80 % C, 13.62 % H, and 21.58 % O<sub>2</sub> by weight. What is the empirical formula for this compound?

1.	Tabulate and assume 100 g		C	H	O
		grams	64.80 g	13.62 g	21.58 g
2.	Convert the masses to moles (divide by the atomic mass)		C	H	O
		grams	64.80 g	13.62 g	21.58 g
		moles	5.396 mol	13.49 mol	1.344 mol
3.	Divide by the lowest, seeking the smallest whole-number ratio		C	H	O
		grams	64.80 g	13.62 g	21.58 g
		moles	5.396 mol	13.49 mol	1.344 mol
		simplest ratio	4	10	1
4.	Write the empirical formula	$C_4H_{10}O$			



### Derive the molecular formula from the empirical formula

From the previous, derive the molecular formula if the molecular mass is  $222.4 \text{ g mol}^{-1}$ .

1.	$\frac{\text{molecular mass}}{\text{mass of the empirical formula}}$	$\frac{222.4 \text{ g mol}^{-1}}{4 \cdot 12.01 + 10 \cdot 1.01 + 16.00 \text{ g mol}^{-1}} = 3$
2.	write the molecular formula	$\text{C}_{12}\text{H}_{30}\text{O}_3$ (since the molecule is 3 times the mass of the empirical formula)

To determine the molecular formula instead of the empirical formula, the molecular mass must also be given.

### Phase changes and states of matter

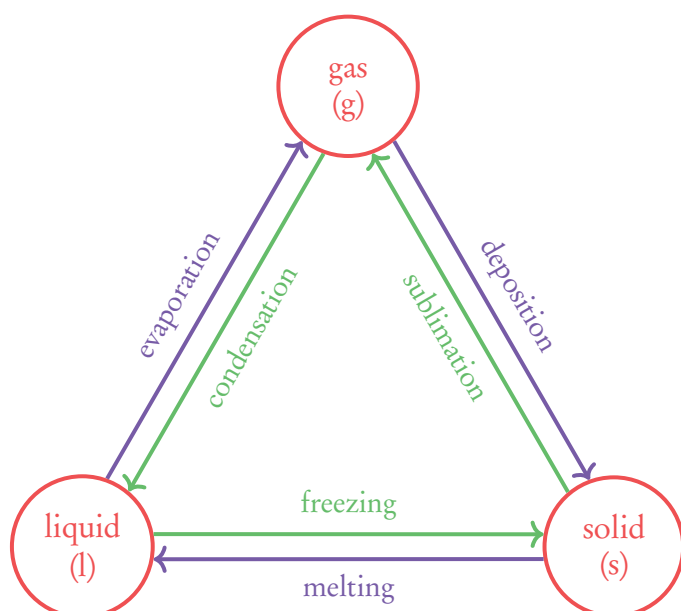

The *state* of a substance is indicated as (s), (l) or (g).

Additionally, when a substance is dissolved in water we can indicate the phase as (aq).

	solid (s)	liquid (l)	gas (g)
<b>movement of particles</b>	vibrational	free movement	free movement
<b>distance between particles</b>	close	close	far apart
<b>fixed volume</b>	yes	yes	no, compressable
<b>fixed shape</b>	yes, rigid	no	no

## 1.2 Chemical reactions



**Chemical reaction** a process that leads to the transformation of one set of chemical substances to another, thus changing their chemical formulae

**Combustion reaction** a chemical reaction between a fuel and  $O_2$ ; which compounds form depends on which elements the fuel contains

fuel contains	combustion product	effect (environmental)
C	$CO_2$ (complete)	greenhouse gas
	CO (incomplete)	toxic to animals
H	$H_2O$	—
S	$SO_2$	acid rain (see chapter 8)
N	$NO_x$	acid rain (see chapter 8)

### Balancing and stoichiometry

To balance reactions we use the **conservation of mass**, which states that the number of atoms before and after a reaction must be equal, and the **conservation of charge**, which states that the charge before and after a reaction must also be equal.



**Stoichiometric coefficients** the numbers placed in front of substances in order to balance chemical reactions

**Stoichiometry** the quantitative relationships between substances in a chemical reaction (molar ratios)

Example.

Balance the reaction:  $\dots C_{10}H_{22} + \dots O_2 \longrightarrow \dots H_2O + \dots CO_2$

The trick to balancing chemical reactions is to *balance elements in order of occurrence*. Both C and H occur in one substance before and after the reaction arrow, so balance these first:  $1 C_{10}H_{22} + O_2 \longrightarrow 11 H_2O + 10 CO_2$

Next, balance O:  $1 C_{10}H_{22} + \frac{31}{2} O_2 \longrightarrow 11 H_2O + 10 CO_2$  (multiply by 2)

$2 C_{10}H_{22} + 31 O_2 \longrightarrow 22 H_2O + 20 CO_2$

## 1.3 Mole concept and chemical calculations



**Mole ( $n$ )** the amount of substance which contains  $N_A = 6.02 \times 10^{23}$  particles (atoms, molecules, ions, electrons, or other physical particles)

**Avogadro's constant ( $N_A$ )**  $6.02 \times 10^{23}$  particles/mol

When buying eggs, you can request one dozen eggs from old-lady Mme. Oeuf. It is a convenient expression, since the packaging contains 12 eggs. So a dozen is an alternative way to express “12”.

The mole is analogously an alternative way to express the number of entities ( $6.02 \times 10^{23}$ ). This number is convenient to represent chemical amounts.

A dozen is a grouping of 12, so:  
2 dozen is a grouping of 24.

A mole is a grouping of  $6.0 \times 10^{23}$ , so:  
2 mole is a grouping of  $1.2 \times 10^{24}$ .

The mole concept is a necessity in chemical calculations. Since we constantly deal with *huge* numbers of particles in chemistry, expressing the number of particles in moles is more convenient. But more importantly, particles react and form in a particular stoichiometric ratio (molar ratio) in chemical reactions.

Take  $2\text{H}_2 + \text{O}_2 \longrightarrow 2\text{H}_2\text{O}$ ; two molecules of  $\text{H}_2$  will react with one molecule of  $\text{O}_2$ .

This *does not* mean that two grams of  $\text{H}_2$  will react with one gram of  $\text{O}_2$ , since the masses of  $\text{H}_2$  and  $\text{O}_2$  molecules are not equal. This *does* mean that two moles of  $\text{H}_2$  will react with one mole of  $\text{O}_2$ , but also that  $1.8 \times 10^{-3}$  mol  $\text{H}_2$  will react with  $0.9 \times 10^{-3}$  mol  $\text{O}_2$ . Furthermore, in chemistry we constantly use huge ensembles of molecules. Using moles allows us to use much simpler numbers.

## Relative and average mass



The relative masses are all measured relative to the **atomic mass unit (u)**: defined as  $1/12$  of the atomic mass of a  $^{12}\text{C}$  atom. And they are all average: the weighed arithmetic mean of all isotopes and their terrestrial natural abundancies.

**Relative atomic mass ( $A_r$ )** the weighed mean of all the isotopes of one element and their natural abundances, relative to one **atomic mass unit**, which is  $1/12$  of the mass of a  $^{12}\text{C}$  atom

**Relative molecular mass ( $M_r$ )** is the sum of the relative atomic masses of all the atoms in the molecular formula

**Relative formula mass ( $M_r$ )** applies to ionic compounds, and it is similar to the relative molecular mass and also calculated in the same way.

**Molar mass  $M$**  the mass of a substance *per one mole* expressed in  $\text{g mol}^{-1}$

Molecules have a well-defined number of atoms, but ionic compounds do not consist of a particular number of ions, rather of ions in a particular ratio.

### 1.3.1 Unit conversion

#### Roadmap to chemical calculations

It is much easier to measure some physical quantity of a sample, such as its mass, than it is to count the number of particles in the sample. Therefore, you will have to convert various quantities to mole and back. The figure below gives an overview of the quantities that can be converted to moles and back, and what other quantity you will need to do so.

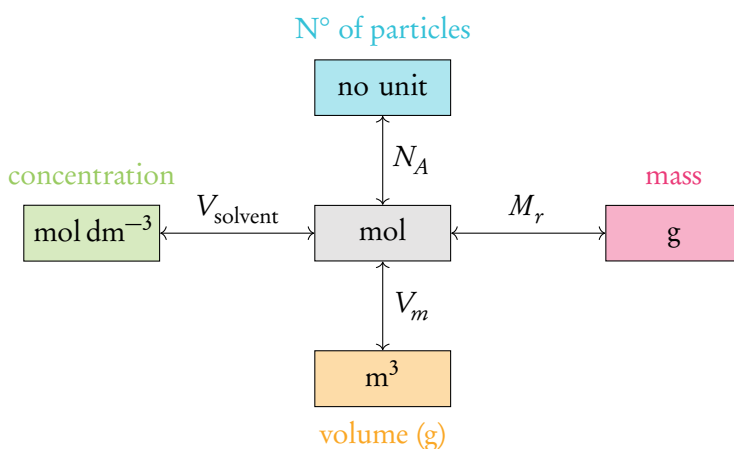

## Mole ↔ number of particles

The number of particles can be expressed in the amount of moles, or in the number of particles. Because  $1 \text{ mol} = 6.02 \times 10^{23}$  particles. The quantities express the same thing, but use different values in doing so. It's like saying "a dozen eggs" to express 12 eggs.

The relationship between the number of particles and the amount in mol is given by:

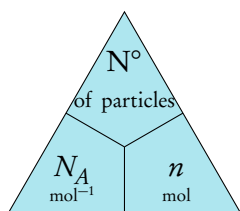

$$N^\circ \text{ of particles} = n \cdot N_A$$

$$\begin{aligned} N^\circ \text{ of particles} &= \text{amount} && [\text{no units}] \\ n &= \text{chemical amount} && [\text{mol}] \\ N_A &= \text{Avogadro's constant} && 6.02 \times 10^{23} \text{ mol}^{-1} \end{aligned}$$

Example.

How many N-atoms are there in  $1.0 \times 10^{-2} \text{ mol NH}_3\text{NO}_3$ ?

$N^\circ \text{ of particles} = n \cdot N_A = 1.0 \times 10^{-2} \text{ mol} \cdot 6.02 \times 10^{23} \text{ mol}^{-1} = 6.02 \times 10^{21}$  molecules,  
per molecule there are 2 N-atoms (mole ratio molecules : N-atoms = 1 : 2),  
so  $2 \cdot 6.02 \times 10^{21} = 1.2 \times 10^{22}$  N-atoms.

What is the total number of atoms in 0.20 mol of propanone,  $\text{CH}_3\text{COCH}_3$ ?

$N^\circ \text{ of particles} = n \cdot N_A = 0.20 \text{ mol} \cdot 6.02 \times 10^{23} \text{ mol}^{-1} = 1.2 \times 10^{23}$  molecules,  
per molecule there are 10 atoms (mole ratio molecules : atoms = 1 : 10),  
so  $10 \cdot 1.2 \times 10^{23} = 1.2 \times 10^{24}$  atoms.

## Mole ↔ gram

The molar mass ( $M$ ) can be calculated from *the formula of the substance*, which is the mass of a substance per one mole particles (in  $\text{g mol}^{-1}$ ). It allows us to convert between the mass and the amount of particles in moles.

The relationship between the amount in mol and mass in g is given by:

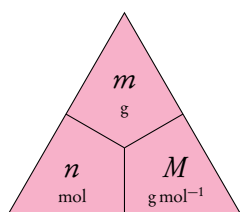

$$m = n \cdot M$$

$$\begin{aligned} m &= \text{mass} && [\text{g}] \\ n &= \text{chemical amount} && [\text{mol}] \\ M &= \text{molar mass} && [\text{g mol}^{-1}] \end{aligned}$$

Example.

What is the amount in moles of 4.00 g in NaOH?

$$M(\text{NaOH}) = 22.99 + 16.00 + 1.01 = 40.0 \text{ g mol}^{-1}$$

$$n = \frac{m}{M} = \frac{4.00 \text{ g}}{40.0 \text{ g mol}^{-1}} = 0.100 \text{ mol NaOH}$$

## Mole ↔ [concentration]



**Solution** a homogeneous mixture of a substance (**the solute**) dissolved in another substance (**the solvent**)

**(Molar) concentration (C)** is the amount of solute (in mol) per unit volume (in  $\text{dm}^3$ ), often written using [...], and expressed in  $\text{mol dm}^{-3}$

**Standard solution** a solution with a known concentration of solute

The solute concentration is independent of the solvent volume. When we dissolve 4 mol sugar in  $2 \text{ dm}^3$  water, it has a particular 'sweetness'. This sweetness is a measure of the concentration of sugar in water. If we would pour out  $1 \text{ dm}^3$  from the solution, it would still be equally sweet (same concentration) but only contain half the sugar content (half the amount in moles).

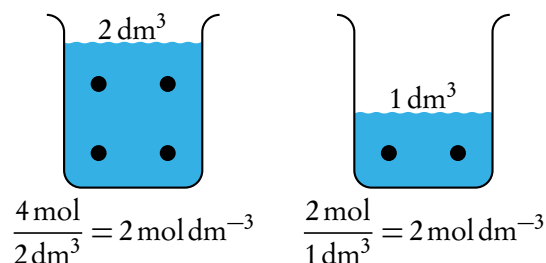

The relationship between the amount in mol and concentration in  $\text{mol dm}^{-3}$  is given by:

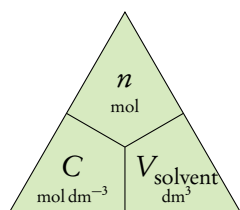

$$n = V_{\text{solvent}} \cdot C$$

$n$  = chemical amount [mol]  
 $V_{\text{solvent}}$  = solvent volume [ $\text{dm}^3$ ]  
 $C$  = concentration [ $\text{mol dm}^{-3}$ ]

It's very useful to remember that  $\text{cm}^3 \cdot \text{mol dm}^{-3} = \text{mmol}$

Example.

**What amount of NaCl (in moles) is required to prepare  $250 \text{ cm}^3$  of a  $0.200 \text{ mol dm}^{-3}$  solution?**

$$n = V_{\text{solvent}} \cdot C = 250 \text{ cm}^3 \cdot 0.200 \text{ mol dm}^{-3} = 50 \text{ mmol}$$

**Which solution contains the greatest amount (in mol) of solute?**

	$V_{\text{solvent}}$	$\cdot C$	= $n$ in mol
A. $10.0 \text{ cm}^3$ of $0.500 \text{ mol dm}^{-3}$ NaCl	10.0	$\cdot 0.500$	= 5 mmol
B. $20.0 \text{ cm}^3$ of $0.400 \text{ mol dm}^{-3}$ NaCl	20.0	$\cdot 0.400$	= 8 mmol
C. $30.0 \text{ cm}^3$ of $0.300 \text{ mol dm}^{-3}$ NaCl	30.0	$\cdot 0.300$	= 9 mmol ←
D. $40.0 \text{ cm}^3$ of $0.200 \text{ mol dm}^{-3}$ NaCl	40.0	$\cdot 0.200$	= 8 mmol

## Mole ↔ volume gas



**Avogadro's law** equal volumes of *all* gases, at the same temperature and pressure, have the same number of molecules

**Molar volume ( $V_m$ )** the volume of one mole gas, expressed in  $\text{dm}^3 \text{mol}^{-1}$  or  $\text{m}^3 \text{mol}^{-1}$ , at a particular pressure and temperature.

Assuming the gas is an ideal gas, Avogadro's law is tested quite often: it should be understood that the molar ratio can be applied to gas volumes.

The volume of an ideal gas at constant temperature and pressure is proportional to the number of particles (in moles). So when twice the number of particles are placed into a cylinder, then the volume becomes twice as large. The volume of one mole gas (**molar volume**) at STP is  $22.7 \text{ dm}^3 \text{ mol}^{-1}$ .

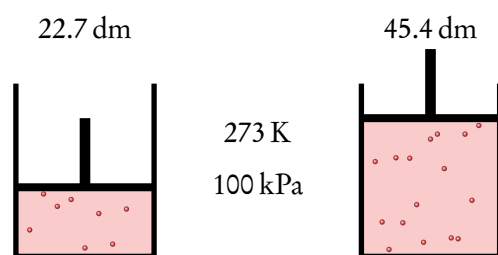

The relationship between the amount in mol and gaseous volume in  $\text{dm}^3$  is given by:

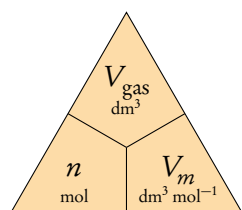

$$V_{\text{gas}} = n \cdot V_m$$

$n$  = chemical amount [mol]  
 $V_{\text{gas}}$  = gas volume [ $\text{dm}^3$ ]  
 $V_m$  = molar volume [ $\text{dm}^3 \text{mol}^{-1}$ ]

## Example

Calculate the volume of nitrogen gas produced by the decomposition of 2.50 mol of  $\text{NaN}_3(\text{s})$  at STP in the reaction  $2\text{NaN}_3(\text{s}) \longrightarrow 2\text{Na}(\text{s}) + 3\text{N}_2(\text{g})$ .

Since the molar ratio  $\text{NaN}_3 : \text{N}_2 = 2 : 3$ ,  $\frac{2.50 \text{ mol}}{2} \times 3 = 3.75 \text{ mol N}_2$  forms.

At STP  $V_m = 22.7 \text{ dm}^3 \text{ mol}^{-1}$ ,  $V_{\text{gas}} = n \cdot V_m = 3.75 \cdot 22.7 = 85.1 \text{ dm}^3$

## 1.3.2 Gas laws and ideal gases

An **ideal gas** is a theoretical gas that assumes that: *the volume of particles is negligible compared to the volume of the surrounding empty space, and no kinetic energy is lost in the collisions between the particles.* Whether these assumptions are justified is outside the scope of the IB syllabus, so from now on we will treat all gases as ideal gases.



**Pressure** the force exerted by the collisions of particles on the walls of its container

$$\text{pressure at sea level} = 100 \text{ kPa} = 1.00 \times 10^5 \text{ Pa}$$

**Temperature** the average kinetic energy of particles

$$T_{\text{in K}} = T_{\text{in } ^\circ\text{C}} + 273 \quad \text{and} \quad T_{\text{in } ^\circ\text{C}} = T_{\text{in K}} - 273$$

**STP** standard temperature and pressure: 273 K and 100 kPa

**SATP** standard ambient temperature and pressure: 298 K and 100 kPa

The **ideal gas law** assumes ideal gas behaviour, and it is an equation that relates the pressure, volume, amount in moles and the temperature of a gas. Critically, SI units *must* be used in the ideal gas law:

Memorize the ideal gas law:  $pV = nRT$ . For paper 2 you will have it in the databook, but you will also need it for paper 1 questions!

$$pV = nRT$$

$p$ = pressure	[Pa]
$V$ = volume	[m <sup>3</sup> ]
$n$ = amount of substance	[mol]
$R$ = ideal gas constant	8.31 J K <sup>-1</sup> mol <sup>-1</sup>
$T$ = temperature	[K]

Example.

Using the ideal gas law, verify that  $V_m$  at STP is  $22.7 \text{ dm}^3 \text{ mol}^{-1}$ .

Molar volume ( $V_m$ ) = the volume ( $V$ ) per mole ( $n$ ), or  $V_m = \frac{V}{n}$ .

Rearrange the ideal gas law:  $\frac{V}{n} = \frac{RT}{p} = V_m$

$$V_m = \frac{RT}{p} = \frac{8.31 \cdot 273 \text{ K}}{1.00 \times 10^5 \text{ Pa}} = 2.27 \times 10^{-2} \text{ m}^3 \text{ mol}^{-1} = 22.7 \text{ dm}^3 \text{ mol}^{-1}$$



Questions involving the ideal gas law in paper 1 are often presented ‘at constant mass’; this means that the number of moles  $n$  is kept constant.  $R$  is also a constant. Rearranging the ideal gas law with the variables to one side, and the constants to the other yields:

$\frac{pV}{T} = nR$ . Since only  $p$ ,  $V$  and  $T$  are allowed to change,  $nR$  will remain constant.

Mathematically, two situations (1) and (2) can be related by:

$$nR = \frac{p_1 V_1}{T_1} = \frac{p_2 V_2}{T_2}$$

From  $\frac{p_1 V_1}{T_1} = \frac{p_2 V_2}{T_2}$  we can derive Boyle’s law, Charles’ law and Gay-Lussac’s Law (and Wikipedia knows which is which). In each of the three gas laws, one of the quantities ( $p$ ,  $V$  or  $T$ ) is fixed, as well  $n$  (‘at constant mass’).

Memorize this formula or how to derive it, because it will allow you to answer all questions regarding gas laws!

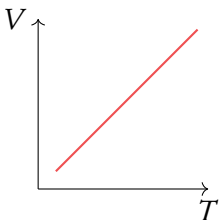
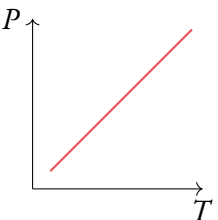
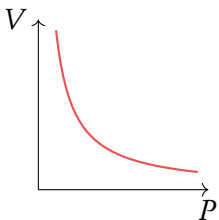
	constant pressure	constant volume	constant temperature
derivation of gas law	$\frac{\cancel{p_1} V_1}{T_1} = \frac{\cancel{p_2} V_2}{T_2}$ $\frac{V_1}{T_1} = \frac{V_2}{T_2}$	$\frac{p_1 \cancel{V_1}}{T_1} = \frac{p_2 \cancel{V_2}}{T_2}$ $\frac{p_1}{T_1} = \frac{p_2}{T_2}$	$\frac{p_1 V_1}{\cancel{T_1}} = \frac{p_2 V_2}{\cancel{T_2}}$ $p_1 V_1 = p_2 V_2$
relation	$V \propto T$	$p \propto T$	$p \propto \frac{1}{V}$
graph			

Example.

At constant temperature, sketch a diagram that shows how  $p$  changes when  $V$  changes.

$p_1 V_1 = p_2 V_2$  holds, so put in some numbers to figure out the relation.

Assume  $p_1 V_1 = 1 \cdot 1 = 1$ :

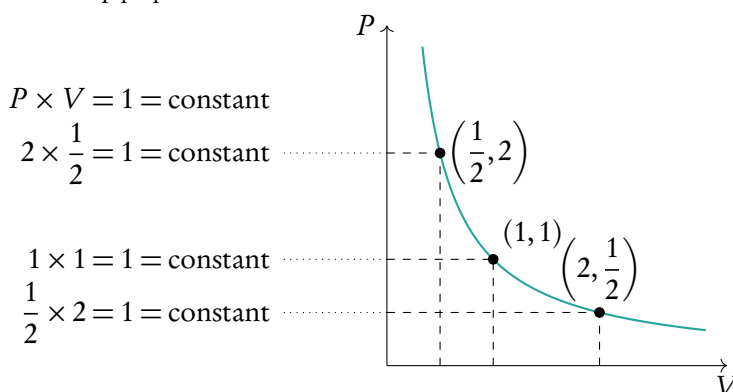

### 1.3.3 Chemical calculations

The basics of all chemical calculations can be summarized as follows:

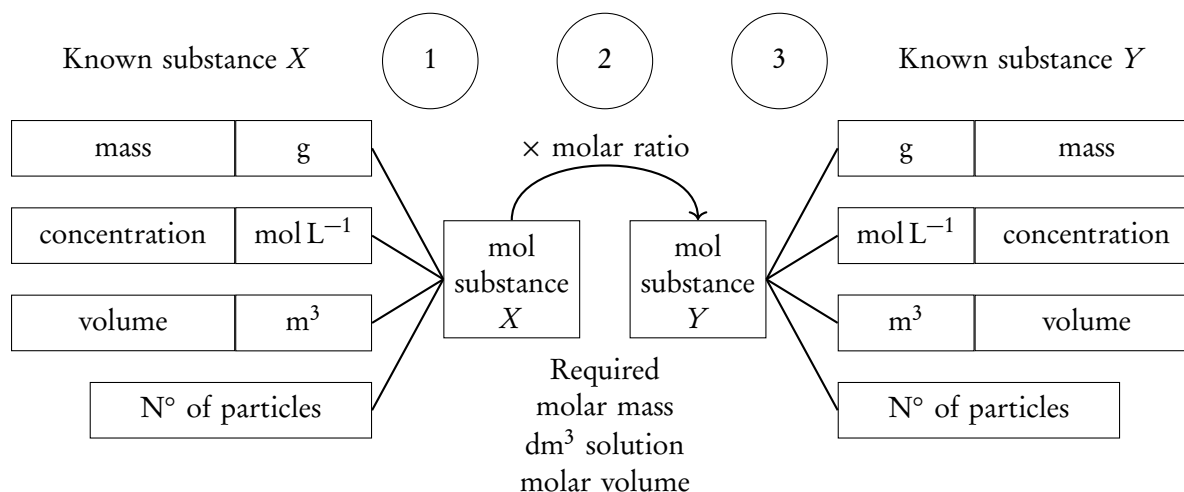

#### Performing chemical calculations

5.0 g of CH<sub>4</sub> undergoes complete combustion. Calculate the volume of the resulting gases under STP assuming that water forms as a gas.

- |    |   |  |
|----|---|--|
| 1. | Note the reaction equation and list the information given                           | $\text{CH}_4 + 2\text{O}_2 \longrightarrow \text{CO}_2 + 2\text{H}_2\text{O}$ 5.0 g CH <sub>4</sub>  |
| 2. | Convert units to mole   | $\text{CH}_4 M_m = 12.0 + 4 \cdot 1.01 = 16.04 \text{ g mol}^{-1}$<br>$\frac{5.0}{16.04} = 0.312 \text{ mol CH}_4$   |
| 3. | Use the molar ratio to convert to the number of moles of the substance(s) asked for | The volume of all the gases that form is required. Per 1 mol CH <sub>4</sub> , 3 mol gas forms<br>$0.312 \text{ mol CH}_4 \cdot \frac{3}{1} = 0.935 \text{ mol gas.}$                          |
| 4. | Convert moles to required units   | Under STP $V_m = 24.5 \text{ dm}^3 \text{ mol}^{-1}$ ,<br>$0.935 \text{ mol} \cdot 24.5 \text{ dm}^3 \text{ mol}^{-1} = 22.9 \text{ dm}^3$   |
| 5. | Check significant figures and units   | Looking back to step 1 the amount of CH <sub>4</sub> is given in two significant figures, so the answer should also be written using two significant figures $\longrightarrow 23 \text{ dm}^3$ |

## Limiting and excess reactant

12 table legs and 4 table tops are stored in the warehouse of a table factory. Our intuition tells us that we cannot make 4 tables, since it would require 16 table legs. So even though more table legs are available than table tops, due to the ratio in which they are needed the table legs are the **limiting reactant** and the table tops are in **excess**. Doing chemistry we do not have the same intuition, but we perform the same math.



**Theoretical yield** the maximum quantity of product that can be obtained from given quantities of reactants, assuming completion

**Limiting reactant** the reactant that determines the theoretical yield of a product, after the reaction is complete there will be none left

**Excess reactant** the reactant that is not used up by the reaction, after the reaction is complete this substance will still be present

All calculations must be done using the amount of the limiting reactant, since it determines how much product will be made (i.e. the available 12 table legs determine that the theoretical yield of tables is 3).

### Identify the limiting reactant

4.22 g Al reacts with 25.0 g Br<sub>2</sub> in the following reaction:  $2\text{Al} + 3\text{Br}_2 \longrightarrow 2\text{AlBr}_3$ . Identify the limiting reactant and use it to determine the theoretical yield of AlBr<sub>3</sub>.

1. Convert units to moles

$$\frac{4.22 \text{ g}}{26.98 \text{ g mol}^{-1}} = 0.156 \text{ mol Al}$$

$$\frac{25.0 \text{ g}}{2 \cdot 79.90 \text{ g mol}^{-1}} = 0.156 \text{ mol Br}_2$$

2. Divide the number of moles of each reactant by its reaction coefficient. The reactant with the lowest result will be the limiting reactant.

$$\text{Al: } \frac{0.156 \text{ mol}}{2} = 0.078$$

$$\text{Br}_2: \frac{0.156 \text{ mol}}{3} = 0.052$$

So Br<sub>2</sub> is the limiting reactant.

3. Use the number of moles of the *limiting reactant* from step 1 and the molar ratio to calculate the number of moles of the requested substance

The molar ratio of AlBr<sub>3</sub> : Br<sub>2</sub> = 2 : 3, so

$$0.156 \text{ mol} \cdot \frac{2}{3} = 0.104 \text{ mol AlBr}_3$$



# ATOMIC STRUCTURE

## 2.1 Types of particles

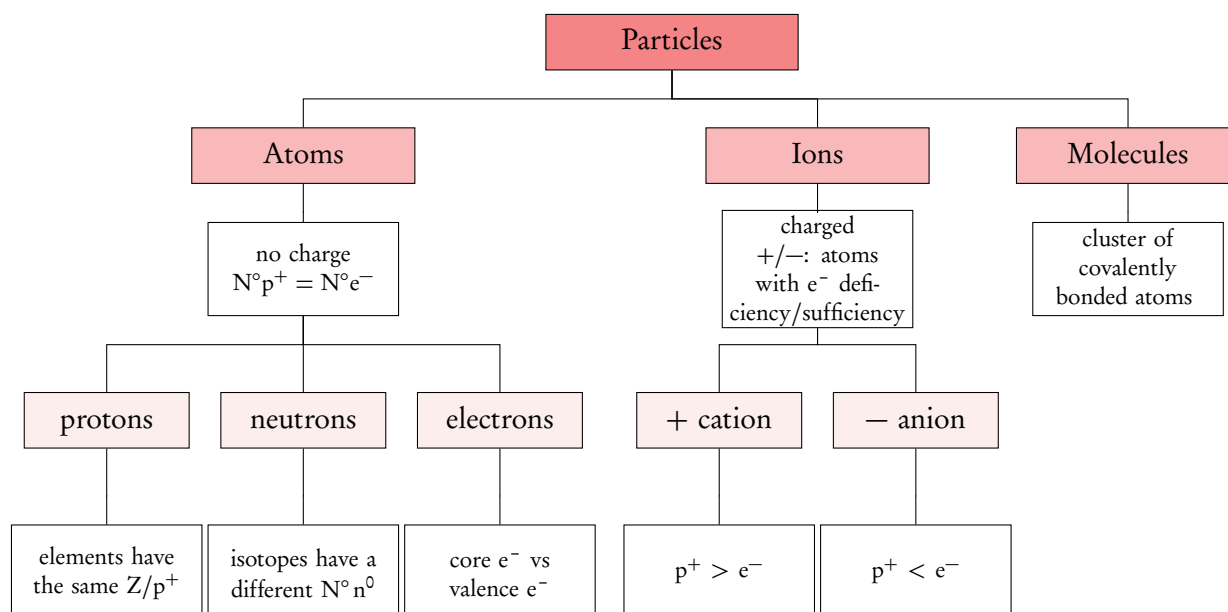

Atoms contain **subatomic particles**: protons, neutrons and electrons

**Nucleus** ⊕ protons and neutrons form the atom's nucleus

**Electron cloud** ⊖ electrons occupy the space outside the nucleus in shells/subshells/orbitals

	notation	mass	relative mass	charge	relative charge
proton	$p^+$	$1.67 \times 10^{-24}$ g	1 u	$1.60 \times 10^{-19}$ C	+1
neutron	$n^0$	$1.67 \times 10^{-24}$ g	1 u	0 C	0
electron	$e^-$	$9.11 \times 10^{-28}$ g	$\approx 0$ u	$-1.60 \times 10^{-19}$ C	-1



anion: a negative ion

cation: is positive

Isotopes have the same chemical properties, but different physical properties

**Atom** charge = 0. the smallest constituent unit of ordinary matter that has the properties of a chemical element

**Ion** charge  $\neq 0$ , so the number of  $e^- \neq$  the number of  $p^+$

**Negative ion/anion**  $\ominus$  contains *more*  $e^-$  than  $p^+$

**Positive ion/cation**  $\oplus$  contains *less*  $e^-$  than  $p^+$

**Element** all atoms of the same element have the same number of  $p^+$  (i.e. the same atomic number  $Z$ )

**Isotopes** atoms of the same element but with a different number of  $n^0$ , resulting in a different mass number  $^A X$ .

## 2.2 Notation

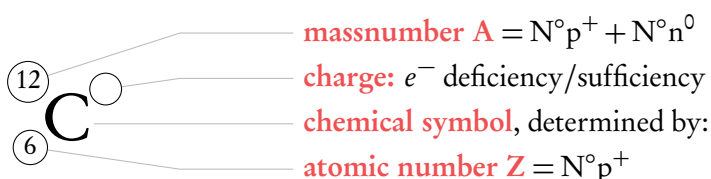

Example.

This atom has 8  $p^+$  and 10  $n^0$ , what is the chemical notation for this ion?

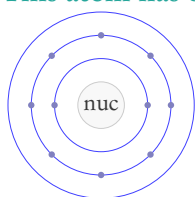

$$\left. \begin{aligned} Z &= N^\circ p^+ = 8 \\ A &= N^\circ p^+ + N^\circ n^0 = 8 + 10 = 18 \\ \text{charge} &= N^\circ p^+ - N^\circ e^- = 8 - 10 = -2 \end{aligned} \right\} {}^{18}_8\text{O}^{2-}$$

$\ominus$  ions have extra  $e^-$ !

Find the symbol,  $Z$ ,  $p^+$ ,  $n^0$ ,  $e^-$  for:  ${}^{11}_5 X$ ,  ${}^{19}_9 X^-$  and  ${}^{27} Al^{3+}$

	Symbol and $Z$	$N^\circ p^+$	$N^\circ n^0$	$N^\circ e^-$
${}^{11}_5 X$	$Z = 5$ , so B	5	$11 - 5 = 6$	5
${}^{19}_9 X^-$	$Z = 9$ , so F	9	$19 - 9 = 10$	$9 + 1 = 10$
${}^{27} Al^{3+}$	Al, so $Z = 13$	13	$27 - 13 = 14$	$13 - 3 = 10$

## 2.3 Isotopes: abundance and $A_r$



**Relative atomic mass ( $A_r$ )** the weighed mean of all the isotopes of one element and their natural abundances, relative to one **atomic mass unit**, which is  $1/12$  of the mass of a  $^{12}\text{C}$  atom

$1 \text{ u} = 1 \text{ g mol}^{-1}$

$$A_r = \left( \begin{array}{l} \text{fractional} \\ \text{abundance} \\ \text{of isotope 1} \end{array} \times \begin{array}{l} \text{mass of} \\ \text{isotope 1} \end{array} \right) + \left( \begin{array}{l} \text{fractional} \\ \text{abundance} \\ \text{of isotope 2} \end{array} \times \begin{array}{l} \text{mass of} \\ \text{isotope 2} \end{array} \right) + \dots$$

Example.

Calculate  $A_r$  of bromine, given that the abundances of  $^{79}\text{Br}$  and  $^{81}\text{Br}$  are 50.69 % and 49.31 %.

$$\begin{aligned} A_r(\text{Br}) &= 50.69\% \cdot ^{79}\text{Br} + 49.31\% \cdot ^{81}\text{Br} \\ &= 0.5069 \cdot 79 + 0.4931 \cdot 81 \\ &= 79.90 \text{ g mol}^{-1} \end{aligned}$$

Calculate the abundances of  $^{69}\text{Ga}$  and  $^{71}\text{Ga}$ , given these are the only stable isotopes of Ga and  $A_r = 69.72 \text{ g mol}^{-1}$

Since  $^{69}\text{Ga}$  and  $^{71}\text{Ga}$  are the only stable isotopes we can say that:

fractional abundance  $^{69}\text{Ga}$  + fractional abundance  $^{71}\text{Ga}$  = 1 (or 100 %)

If we let  $x$  = fractional abundance  $^{69}\text{Ga}$  then fractional abundance  $^{71}\text{Ga}$  =  $1 - x$

$$A_r(\text{Ga}) = x \cdot ^{69}\text{Ga} + (1 - x) \cdot ^{71}\text{Ga}$$

$$69.72 \text{ g mol}^{-1} = x \cdot 69 + (1 - x) \cdot 71 = 69x + 71 - 71x$$

$$x = 0.64$$

So the abundance of  $^{69}\text{Ga}$  is 64 % and the abundance of  $^{71}\text{Ga}$  is  $100\% - 64\% = 36\%$

## Mass spectrometer

A mass spectrometer is an analytical instrument that can measure the mass of each isotope in a sample. So if a sample of lead, Pb, is injected into the device, the following spectrum and relative abundances will result:

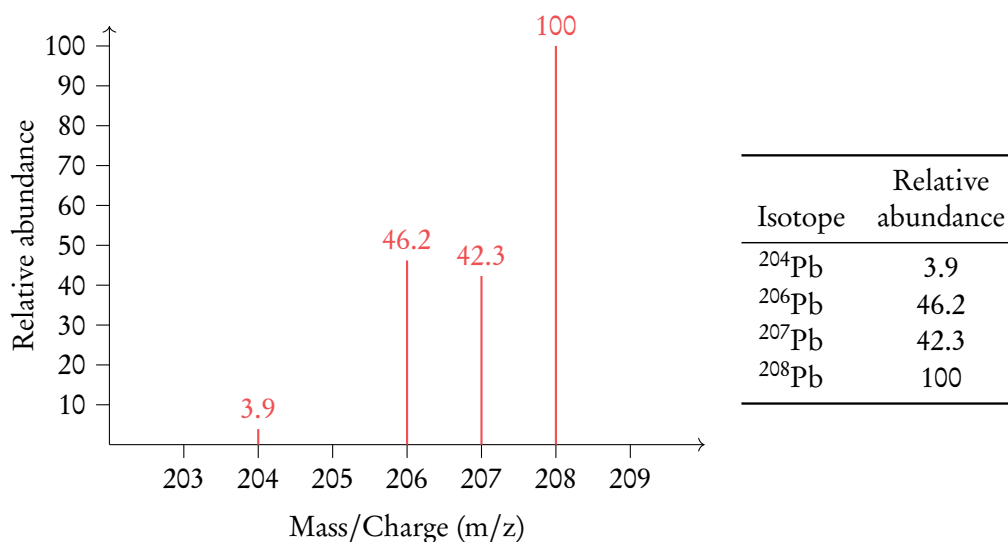

The data of the mass spectrum allows us to calculate the average atomic mass by weighing the isotopic mass against its relative abundance. Note that the abundance is not given as a %, so we have to divide by the sum of all the relative abundances.

$$A_r(\text{Pb}) = \frac{3.9 \cdot 204 + 46.2 \cdot 206 + 42.3 \cdot 207 + 100 \cdot 208}{3.9 + 46.2 + 42.3 + 100} = 207.2 \text{ g mol}^{-1}$$



## 2.4 Atomic shells/subshells/orbitals



**Electron shell  $n = 1, 2, 3 \dots$**  principal energy level which each contains  $2n^2$  electrons, further divided in a number of subshells

**Subshells s, p, d, f** each subshell has a particular number of orbitals, and each has its own geometry

**Atomic orbital** region with a specific geometry that can host two electrons of opposite spin

Electron shell is also often referred to as the *main energy level*

shell $n$	max. N <sup>o</sup> of $e^-$ $2n^2$	N <sup>o</sup> of orbitals				total	electron configuration
		s	p	d	f		
1	$2 \cdot 1^2 = 2$	1	—	—	—	1	$1s^x$
2	$2 \cdot 2^2 = 8$	1	3	—	—	4	$2s^x 2p^x$
3	$2 \cdot 3^2 = 18$	1	3	5	—	9	$3s^x 3p^x 3d^x$
4	$2 \cdot 4^2 = 32$	1	3	5	7	16	$4s^x 4p^x 4d^x 4f^x$

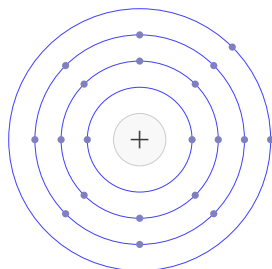

The principal electron shells can be imagined as an onion: the first shell ( $n = 1$ ) is closest to the nucleus and each of the following shells is further away. The shells are numbered:  $n = 1, n = 2, \dots$

Every shell contains the s subshell, from the second shell ( $n = 2$ ) forward all shells contain the p subshell, from the third shell ( $n = 3$ ) all shells contain the d subshell etc.

### The shape of the subshells

Every s subshell consist of one spherical orbital, which is further away from the nucleus the higher the shell number. The p subshell always contains 3 orbitals which are aligned along the  $xyz$ -axis. Since the second shell ( $n = 2$ ) contains the  $2s 2p$  subshells which can host 2 and 6 electrons respectively, the maximum total number of electrons in the second shell is 8.

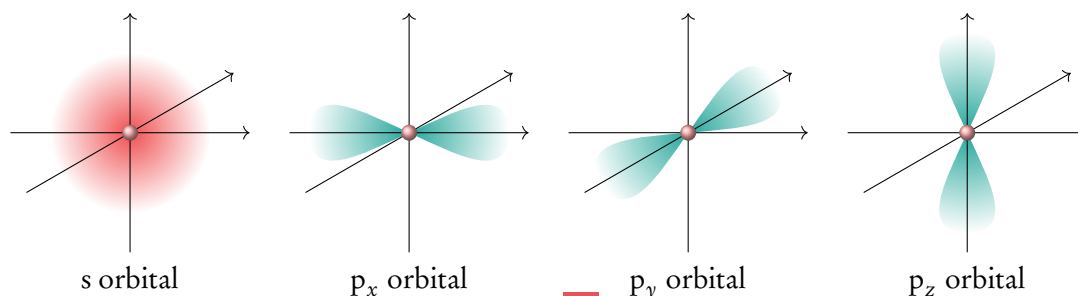

## 2.4.1 Electron configuration



**Electron configuration** shows the number of  $e^-$  in each subshell in the **groundstate** (the lowest energy state)

**Aufbau principle = 1s 2s 2p 3s 3p 4s 3d 4p** electrons are placed into orbitals with *lowest energy* first, which are not necessarily orbitals closest to the nucleus. Importantly: electrons occupy 4s before 3d orbitals.

**Pauli's exclusion principle** per orbital a maximum of 2  $e^-$  with opposite spin are allowed.

**Hund's rule** instead of forming pairs in the same orbital, electrons rather occupy empty orbitals to minimize repulsion.

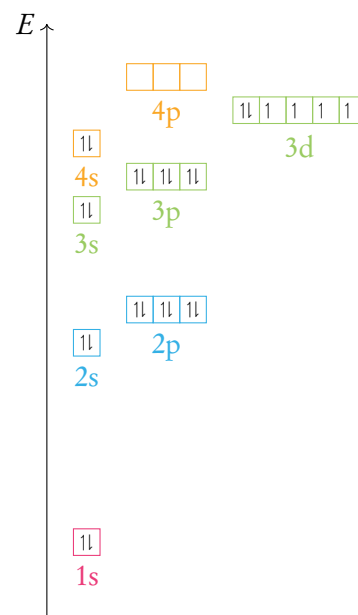

Note that when asked to write the *full electron configuration*, the condensed form is incorrect!

### Write the electron configuration of atoms

Write the *full* and *condensed* electron configuration for Fe.

- |    |   |   |
|----|---|---|
| 1. | Determine the total number of $e^-$   | ${}_{26}\text{Fe}$ , is an atom so:<br>number of $p^+$ = number of $e^-$ = 26 |
| 2. | Allocate each electron to each subshell according to the Aufbau principle. Place max. 2 $e^-$ in the s subshells, max. 6 $e^-$ in the p subshells, max. 10 $e^-$ in d subshell. | $1s^2 2s^2 2p^6 3s^2 3p^6 4s^2 3d^6$<br>Abbreviated form:<br>[Ar] $4s^2 3d^6$ |

To write the electron configuration of ions, we have to add or remove electrons from the electron configuration of the atom equal to the charge of the ion. As the 3d sublevel becomes populated with electrons, the relative energies of the 4s and 3d fluctuate relative to one another and the 4s ends up higher in energy as the 3d sublevel fills. *This means that 4s electrons are removed prior to 3d electrons.*

**Write the electron configuration of ions**

Write the *condensed* electron configuration for Fe<sup>3+</sup>

1.	Write the electron configuration of the atom	[Ar]4s <sup>2</sup> 3d <sup>6</sup>
2.	Add electrons / remove electrons from the outermost shell (4s before 3d)	Fe <sup>3+</sup> has 3 fewer e <sup>-</sup> than the atom. First remove two 4s electrons, and then remove one 3d electron: [Ar] 3d <sup>5</sup>

**d<sup>4</sup> and d<sup>9</sup> exceptions**

The situation when subshells are completely filled, or half-filled, is energetically favoured. An electron from the 4s subshell can be promoted to attain a half-filled d-subshell (d<sup>5</sup>) or full d-subshell (d<sup>10</sup>).

	<b>incorrect</b>	<b>correct</b>
Cr	[Ar] <del>4s<sup>2</sup></del> 3d <sup>4</sup>	[Ar] 4s <sup>1</sup> 3d <sup>5</sup>
Cu	[Ar] <del>4s<sup>2</sup></del> 3d <sup>9</sup>	[Ar] 4s <sup>1</sup> 3d <sup>10</sup>

Memorize these two exceptions because they have been tested often!

**2.5 Electromagnetic spectrum**



**Electromagnetic radiation** a form of energy that propagates through space at the speed of light as electromagnetic waves, or **photons**

$$E_{\text{photon}} = h\nu = \frac{hc}{\lambda}$$

$E_{\text{photon}}$	= energy of a photon [J]
$h$	= Planck's constant $6.63 \times 10^{-34}$ J s
$\nu$ or $f$	= frequency $[s^{-1}]$
$\lambda$	= wavelength [m]

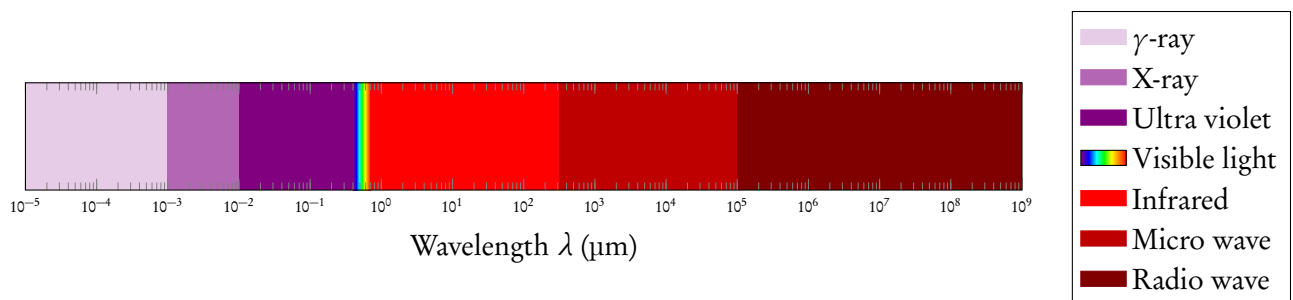

Visible light (Vis) is an example of electromagnetic (EM) radiation. The colour of light is tied to the amount of energy of a photon. But visible light is only a small part of the EM spectrum; at the higher energy end of the spectrum we find ultraviolet (UV), X-ray and γ-ray, at the lower energy end of the spectrum we find infrared (IR), microwaves and radio waves.

## Electron energy levels

The energy level of an electron depends on which atomic orbital it occupies. The lowest energy level is called the **groundstate**; an electron can move to a higher energy level (**excited state**) by absorption of a photon. And similarly, an electron can move from an excited state to a lower energy level by emitting a photon.

The transition between electron energy levels is only possible when the electron absorbs or emits a photon with exactly the same amount of energy as the difference between the energy levels. Energy transitions are **discrete**: of a particular amount of energy.

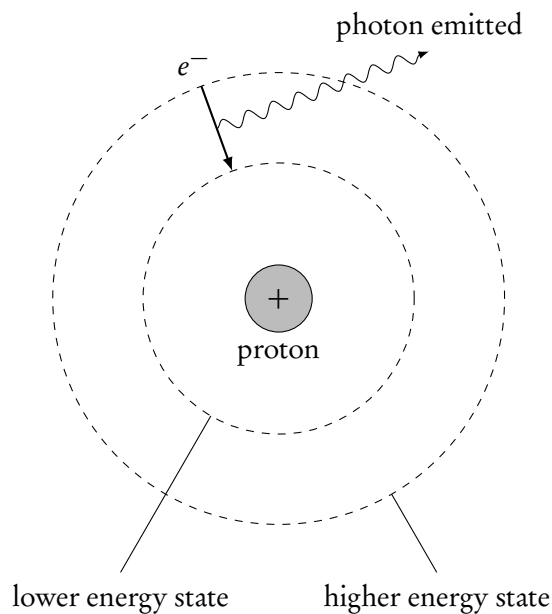

When excited electrons 'fall' from a higher to a lower energy state, photons with a discrete amount of energy are emitted. The emission spectrum of atoms is a **line spectrum**: only light of a particular colour (discrete energy) is emitted.

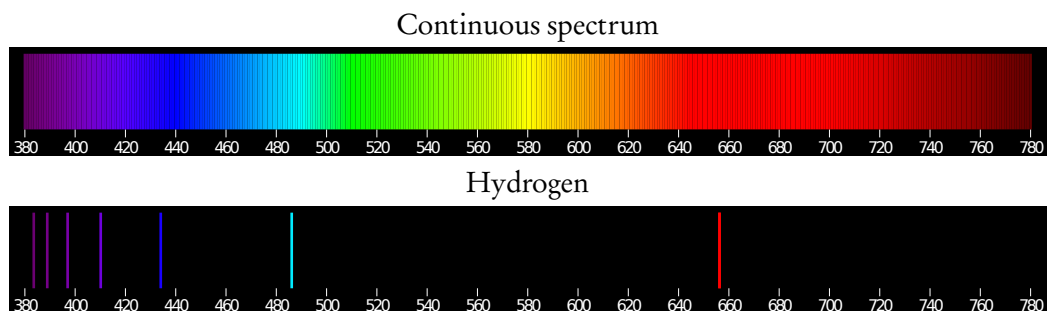

### Hydrogen energy levels

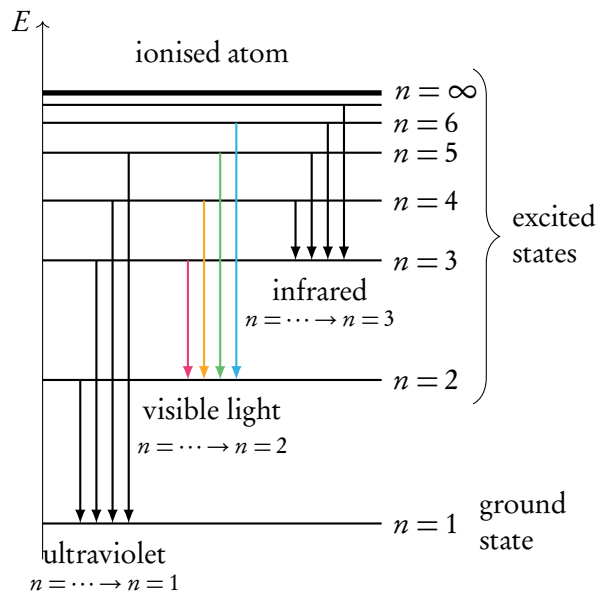
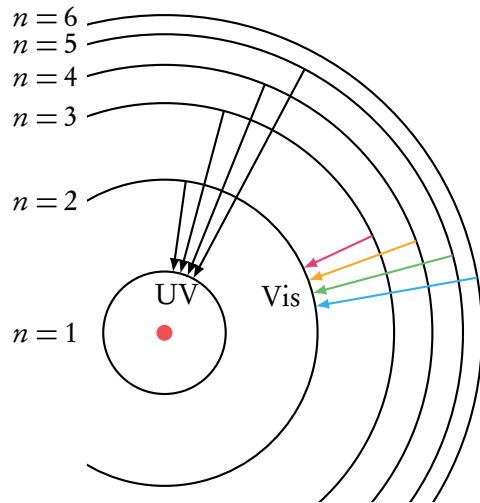

Electrons that ‘fall’ to the groundstate ( $n = 1$ ) emit photons with the greatest amount of energy (UV radiation). The length of the arrows is proportional to the amount of energy. Electrons that ‘fall’ to  $n = 2$  emit visible light and to  $n = 3$  emit infrared radiation.

Also note that the energy levels **converge** at higher energy: the difference between the energy levels becomes smaller up to the point where the difference is 0. The energy difference between the *more energetic photons* is increasingly smaller. Therefore line spectra *converge at higher energy*.



# PERIODICITY

## 3.1 The Periodic Table (PT)



**Period** is a row in the periodic table, and it represents the principal electron shells ( $n = 1, 2, \dots$ )

**Group** is a column in the periodic table, and it groups elements with similar chemical properties due to having the same number of valence  $e^-$

Valence electrons are just the outermost electrons

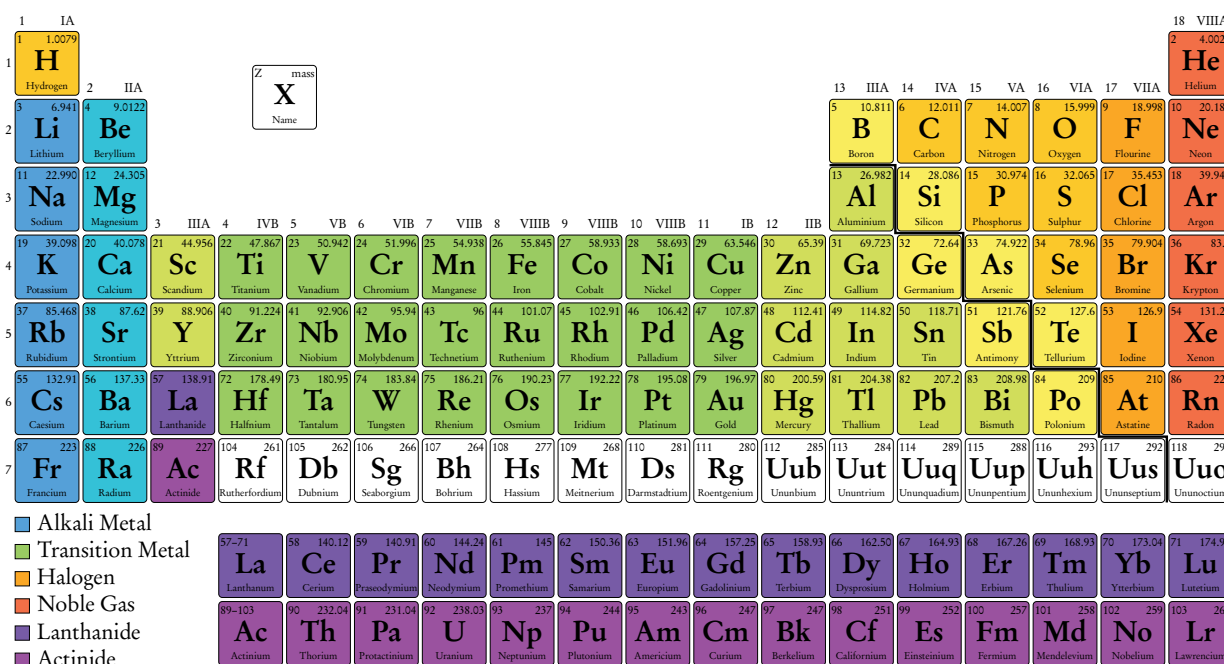

### Element type

**Metals** the majority of elements (in the figure: from blue to green), found on the left in the PT.

**Non-metals** form mostly molecules, (in the figure: from orange to red), found on the right in the PT.

**Metalloids** have intermediate properties

The division between elements that are metals and non-metals starts between Al (which is a metal) and B, and staircases down to the right. Later on it will be assumed knowledge and it is crucial to quickly tell if an element is metallic or not.

If you have never heard of the element, chances are that it's a metal.

## Subshells & blocks

The elements in the periodic table can be divided into four blocks, based on their electronic configuration. Since elements down a group have the same number of valence electrons, they will also have the same outermost subshell configuration.

Take the alkali metals for example: each has a single electron in the outermost shell, but each in a shell further away. The electron configurations of Li, Na and K are  $[\text{He}] 2s^1$ ,  $[\text{Ne}] 3s^1$  and  $[\text{Ar}] 4s^1$  respectively. The shell number that contains those electrons can be read off from the period number.

Note that H has the  $s^1$  configuration but is not a metal, and He has  $s^2$  configuration so we could consider placing it in above Be. But since the valence shell of He is completely full its properties correspond much closer to the noble gases.

The nucleus of fluorine has a charge of  $9+$ , the  $1^{\text{st}}$  shell is full, reducing the effective attractive power of the nucleus to the valence electrons to  $7+$ .

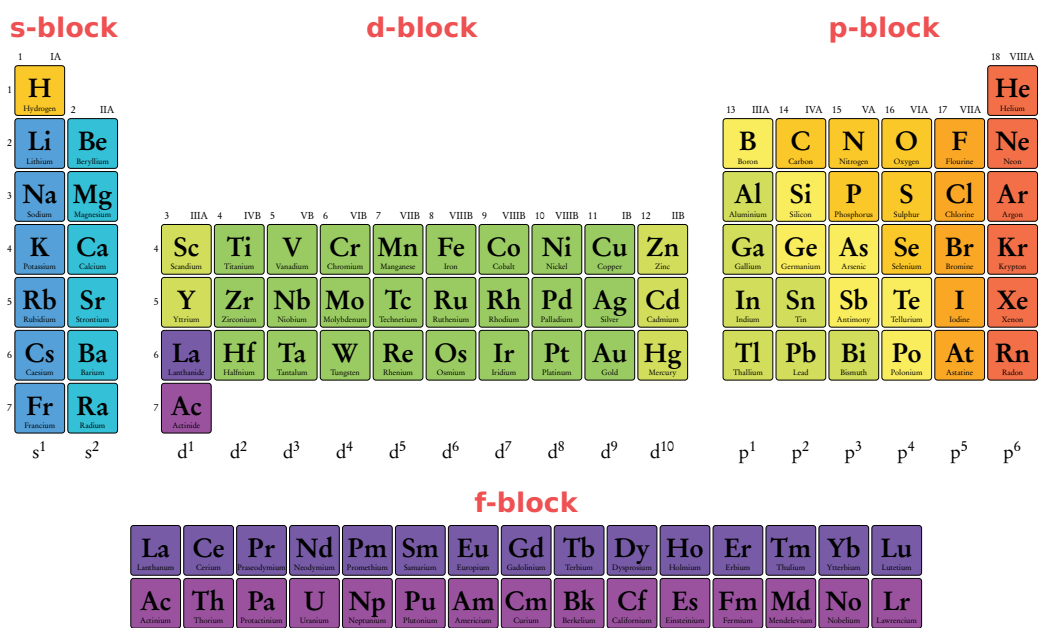

The elements in the first row are called **lanthanides**, and in the second row **actinides**.

## 3.2 Periodic trends

Periodic trends are governed by the balance between attractive and repulsive electrostatic forces between the nucleus and the valence electrons.

**Shielding** electrons in lower *full* electron shells reduce the  $\oplus$ -charge that the valence electrons experience

**Effective nuclear charge ( $Z_{\text{eff}}$ )** the net  $\oplus$  charge that valence electrons experience.

$$Z_{\text{eff}} = Z - N^{\circ} \text{shielding electrons}$$

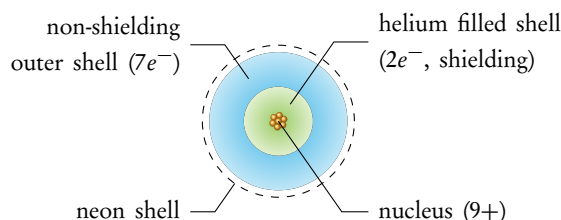

$$Z_{\text{eff}} = 9 - 2 = +7$$









### Attraction ↑ (between the nucleus and the valence $e^-$ )

- a period, because  $Z_{\text{eff}}$  increases (larger charge difference)
- ↑ a group, because distance decreases (larger distance difference)

**Atomic radius** the distance from the nucleus to the valence electron(s).

- When attraction ↑, the atomic radius ↓.

**Ionic radius** the distance from the nucleus to the valence electron(s).

$Z_{\text{eff}}$  and the shell number stay the same, so the attraction stays the same. Only the repelling forces between the valence  $e^-$  changes:

- In  $\oplus$  ions a number  $e^-$  are removed. All things equal, the mutually repelling forces between valence electrons decreases. *The larger the  $\oplus$  charge, the smaller the ion.*
- In  $\ominus$  ions a number of  $e^-$  are added. All things equal, the mutually repelling forces between valence electrons increases. *The larger the  $\oplus$  charge, the larger the ion.*

**Electronegativity** a measure of the ability of an atom to attract  $e^-$  in a covalent bond, i.e. loosely how greedy an element is for electrons

- When attraction ↑, the electronegativity ↑.

**First ionization energy** the energy change when one mole electrons are removed from one mole *gaseous atoms*, forming one mole *gaseous 1+ ions*

- When attraction ↑, the first ionization energy ↑.

**First electron affinity** the energy change when one mole of *gaseous atoms* acquire one mole electrons, forming one mole *gaseous 1- ions*.

- When attraction ↑, the first electron affinity ↑.

The effect of adding or removing one electron while the attraction remains equal is significant. It's safe to assume that + ions are always smaller than atoms, and - ions always larger.

The energies of the first ionisation energy and electron affinity both increase when the attraction increases: it either requires more energy to remove the electron or releases more when it's acquired.

Example.

Order  $\text{Ne}$ ,  $\text{F}^-$  and  $\text{Na}^+$  in decreasing size. Explain why these are *isoelectronic*.

In order to compare the sizes of atoms and ions they have to be **isoelectronic**: i.e. have the same electron configuration. In this case, each has the  $[\text{Ne}]$  electronic configuration, but a different number of  $p^+$  attracting the same number of  $e^-$ . The  $\ominus$  ion will be largest, then the atom, then the  $\oplus$  ion.

Answer:  $\text{Na}^+ < \text{Ne} < \text{F}^-$  or  $\text{F}^- > \text{Ne} > \text{Na}^+$

Read:  $\text{Na}^+$  is smaller than  $\text{Ne}$  is smaller than  $\text{F}^-$ , or the reverse

## Melting and boiling points

**Alkali metals** metallic bond strength increases when the *charge density* increases: smaller atoms with more valence electrons. The number of valence electrons is the same for the alkali metals, and charge density increases with smaller atoms. Li is predicted to have the highest MP and BP.

**Halogens** are apolar molecules with only London dispersion forces between them, which increase with increasing molecular mass. I<sub>2</sub> is predicted to have the highest MP and BP.

The melting and boiling points (MP and BP) of compounds critically depend on the bond strength between the particles, so this section should be understood after bonding is introduced.

## Chemical reactivities

**Alkali metals** all contain 1 electron in their valence shell ( $s^1$ ); in order to attain the noble gas configuration these elements react by *donating* an electron. The easier it is to remove the electron, the more reactive the element. Cs is most reactive and Li least, since all other things equal the  $e^-$  in Cs is furthest away from the nucleus.

**Halogens** all contain 7 electrons in their valence shell ( $s^2p^5$ ); in order to attain the noble gas configuration these elements react by *accepting* an electron. The stronger the attractive force to electrons, the more reactive the element. F<sub>2</sub> is most reactive and I<sub>2</sub> least, since all other things equal the  $e^-$  in F<sub>2</sub> are closer to the nucleus.

Although the more reactive alkali metals and halogens will react more vigorously, they will undergo the same chemical reactions. You have to learn some of these reactions by heart, but fortunately all alkali metals and halogens undergo the same reactions and so they are interchangeable.

Type	Equation	
Alkali metals + water	$2\text{Li} + 2\text{H}_2\text{O} \longrightarrow 2\text{LiOH} + \text{H}_2$ $2\text{Na} + 2\text{H}_2\text{O} \longrightarrow 2\text{NaOH} + \text{H}_2$ ...	forms alkaline solutions and H <sub>2</sub> which can combust (violently)
Alkali metals + halogens	$2\text{Na} + \text{Cl}_2 \longrightarrow 2\text{NaCl}$ $2\text{K} + \text{F}_2 \longrightarrow 2\text{KF}$ ...	forms ionic halides, more reactive alkali metals + more reactive halogens produce a more vigorous reaction
Displacement reactions	$2\text{KBr} + \text{Cl}_2 \longrightarrow 2\text{KCl} + \text{Br}_2$	the more reactive halogen displaces the ions of the less reactive halogen
Ionic reactions	$\left\{ \begin{array}{l} 2\text{Br}^- + \text{Cl}_2 \longrightarrow 2\text{Cl}^- + \text{Br}_2 \\ 2\text{I}^- + \text{Cl}_2 \longrightarrow 2\text{Cl}^- + \text{I}_2 \\ 2\text{I}^- + \text{Br}_2 \longrightarrow 2\text{Br}^- + \text{I}_2 \end{array} \right.$	

Table 3.1: Reactions involving Halogens and Alkali Metals



# BONDING

The most stable electron configuration for each element is when the valence (= outermost) shell is completely occupied; this is known as the noble gas configuration. In order to attain the noble gas configuration atoms will share  $e^-$  (in covalent and metallic bonds) or exchange  $e^-$  (forming ions, and ionic bonds).

Depending on which element types combine we can predict the type of bonding:

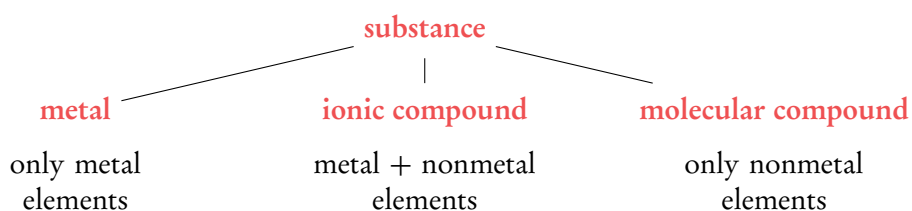

**Electrostatic forces** the attractive and repelling forces between charges.

**Charge density** the ratio between the charge of a particle compared to its size. The greater the charge density is, the greater the electrostatic attraction. Charge density increases when:

- the charge difference is greater, or when
- the distance is smaller between the charges (smaller atoms/ions).

When whole charges attract, such as between ions, the electrostatic forces will be *strong*; and when partial charges attract, such as between  $\delta^-$  and  $\delta^+$ , the electrostatic forces will be *weak*.

This chapter explores how physical (macroscopic) properties of a substance are a consequence of the bonding and arrangement of particles (microscopic properties).

## Physical properties

**melting point (MP) & boiling point (BP):** increases as bond strength increases

**solubility:** like dissolves like

**conduction:** requires *charged particles* that *can move* to carry current.

**malleability / ductility:** depends on how well the substance can adapt to a change in the orientation of its particles.

## 4.1 Metallic Bonding



The valence electrons of metal atoms become detached from individual atoms forming a “**sea of delocalised electrons**”, which can move freely through the lattice of metal nuclei.

**Metallic bond** the attraction due to the attraction of  $\oplus$  metal nuclei to the delocalised “sea of electrons”  $\ominus$  that moves freely

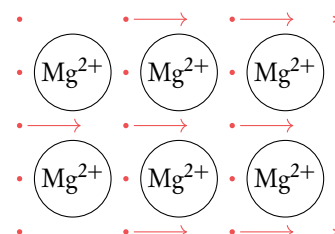

### Bond strength: MP & BP

The MP/BP of metals are high because metallic bonds are typically strong, due to the electrostatic attraction between  $\oplus$  metal nuclei and  $\ominus$  free electrons.

Variation among metals depends on **charge density**, which increases:

- when a metal has *more delocalised electrons*, and
- with *smaller size* of the metal atoms.

Metal	Delocalised $e^-$	Radius	MP
Mg	2	140 pm	650 °C
Na	1	160 pm	98 °C
K	1	227 pm	64 °C

### Malleability / ductility

When metals are reshaped, the positive ions in the metallic lattice slide over each other. The ‘sea of electrons’ adapts to the different orientation, maintaining the metallic bonds.

In alloys, the presence of foreign metal atoms disturb the host metal lattice structure, causing it to become harder to slide over each other. Alloys are less malleable.

### Solubility

Metals *only* dissolve in other metals, to form *alloys*.

Many sources incorrectly state that some metals *dissolve* in acid. Instead, the metal *reacts* with the acid in a redox reaction in which the metal is converted into the metal cation, which is soluble in water:



### Conduction

All metals can conduct electricity: since metals contain *charged particles*: the ‘sea of delocalised electrons’ that *can move freely*. The positive metal ‘ions’ cannot move in the metallic lattice.

## 4.2 Ionic bonding



Ions form when electrons are transferred from one element to another (redox):

- reducing the number of valence electrons, to form a metal cation
- increasing the number of valence electrons, to form a non-metal anion

**Ionic bonds** the attractive electrostatic forces between ions of opposing charge, holding ions in a lattice

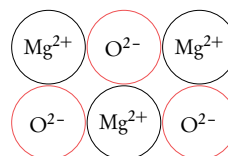

### Bond strength: MP & BP

The MP/BP of ionic compounds are high because ionic bonds are typically strong, due to the electrostatic attraction between  $\oplus$  cations and  $\ominus$  anions.

Variation among ionic compounds depends on **charge density**, which increases:

- when the ionic *charge is larger*, and
- with *smaller size* of the ions.

### Solubility

In order to dissolve ionic compounds, the ionic bonds in the lattice between the ions have to be broken *and replaced* by stronger solvation bonds. The easier the ionic bonds are broken, and the stronger the solvation bonds are, the more soluble the ionic compound is.



**Solvation** solute ions are surrounded by a concentric shell of solvent molecules, forming solvation complexes

**Hydration** is solvation by water molecules

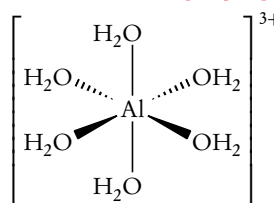

In solution, *conduction is proportional to the concentration of ions.*

### Conduction

All ionic compounds contain ions, which are *charged particles*. But ions in a solid (s) lattice cannot move, and so not conduct electricity. Only when the ionic compound is liquid (l) or dissolved (aq) can the ions move freely, to conduct electricity.

### Malleability

When one row of ions in the ionic lattice moves over 1 place with respect to another row, then all attractive forces between ions of opposing charge become repelling forces between ions of the same charge. This leads to a crack in the material, meaning that ionic compounds are brittle.

### 4.2.1 Ionic compounds



**Ionic compound** positive metal ions and negative non-metal ions form a strong lattice. Ionic compounds are charge neutral, so the empirical formula of ionic compounds balances the amount of positive and negative ions.

Writing the empirical formula for ionic compounds involves balancing the total number of positive and negative charges. Individual ions have a charge, while ionic compounds as a whole are neutral. The formula of ionic compounds is written as the smallest ratio between ions (**empirical formula**) so that the net charge is neutral (e.g.,  $\text{Na}_2\text{O}$ ).



**Polyatomic ions** ions containing more than one element

Ammonium:	$\text{NH}_4^+$	Nitrite:	$\text{NO}_2^-$
Acetate:	$\text{CH}_3\text{COO}^-$	Carbonate:	$\text{CO}_3^{2-}$
Cyanide:	$\text{CN}^-$	Sulfate:	$\text{SO}_4^{2-}$
Hydrogen carbonate:	$\text{HCO}_3^-$	Sulphite:	$\text{SO}_3^{2-}$
Hydroxide:	$\text{OH}^-$	Phosphate:	$\text{PO}_4^{3-}$
Nitrate:	$\text{NO}_3^-$		

Memorize the names and formulae of the polyatomic ions by heart!

#### Write empirical formula of ionic compounds

Write the ionic formula of aluminium sulphite

- Write down the individual ions (from memory!)  $\text{Al}^{3+}$  and  $\text{SO}_3^{2-}$
- Determine the smallest possible ratio of combining the ions to form a neutral compound. Trick: cross multiply the charges charges 3+ and 2-, so  $2 \times 3+$  and  $3 \times -2$
- Write the ionic formula, ratio in subscript. Put brackets ( $\dots$ ) around polyatomic ions if more than 1. *Do not* put charges!  $\text{Al}_2(\text{SO}_3)_3$  using brackets around  $\text{SO}_3^{2-}$  because there is more than one



## 4.3 Covalent bonding

### Nature of covalent bonding: “shared electron pair”

In molecules, non-metal atoms share electrons to achieve the noble gas configuration.

Hydrogen has one electron in its outer shell, so it needs one more in order to achieve the He noble gas configuration. Two hydrogen atoms form a *single covalent bond*: they both donate their 1 available valence electron to form a single shared pair. The shared pair of electrons lies in the region between the two nuclei and is attracted to them both.

While hydrogen achieves the noble gas configuration with 2 electrons in its outer shell, other non-metal atoms require  $8 e^-$  in their valence shell to achieve the noble gas configuration. To determine bonding of those elements we use the **octet rule**.

### Bond strength

Covalent bonds form due to the electrostatic attraction of two  $\oplus$  atomic nuclei to a shared electron pair, and since the electrostatic attraction between whole charges is strong, covalent bonds are also strong bonds (on par with metallic and ionic bonds).

In the table below, the bond strengths and lengths of single, double and triple bonds are compared. Stronger bonds are shorter. Note that a double bond is *less than* twice as strong as a single bond.

		Bond energy	Length
Single	C—C	$346 \text{ kJ mol}^{-1}$	0.154 nm
Double	C=C	$614 \text{ kJ mol}^{-1}$	0.134 nm
Triple	C≡C	$839 \text{ kJ mol}^{-1}$	0.120 nm

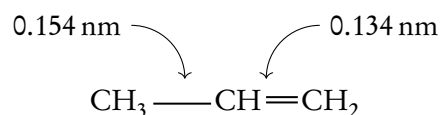

### Nomenclature of simple molecular compounds

- I The number of atoms is prefixed by a Greek numeral prefix.
  1. mono
  2. di
  3. tri
  4. tetra
  5. penta
- II The more electronegative atom is written lastly and is suffixed by *-ide*.

Example.

Molecular formula	Systematic name	Trivial name
$\text{H}_2\text{O}$	dihydrogen oxide	water
$\text{CO}_2$	carbon dioxide	
$\text{CO}$	carbon monoxide	
$\text{S}_2\text{Cl}_2$	disulfur dichloride	

## Coordinate covalent bond = dative bond



**Dative Bond** one atom *donates a non-bonding pair* forming a covalent bond (instead of both of the atoms donating 1 electron). Such a bond can be indicated by an arrow  $\rightarrow$ .

Example.

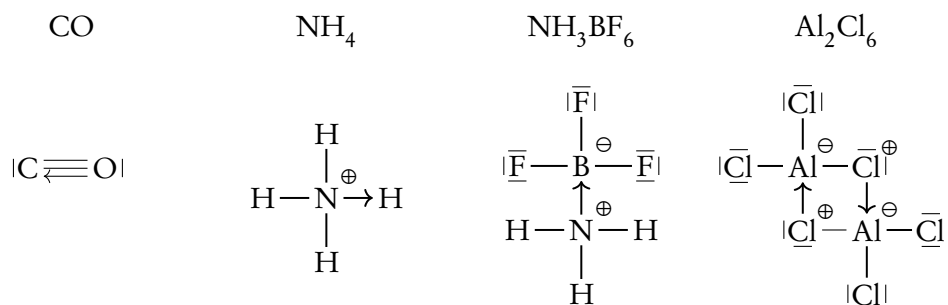

## 4.3.1 Lewis structures



**Bonding electron pair** pair of valence electrons that are shared between atoms (involved in a covalent bond).

**Non-bonding electron pair / lone pair** pair of valence electrons that are not shared between atoms.

**Lewis structures** shows all valence electrons on every atom, bonding *and* non-bonding, using either lines, crosses, dots or a combination

**Octet rule** atoms tend to form a stable arrangement with 8 electrons in their valence shell = 4 e<sup>-</sup>-pairs, corresponding to the noble gas configuration.

Only line notation is used in this study guide

Importantly, some elements never deviate from the octet rule while others regularly do. This has to do with the max. number of electrons that are allowed in the valence shell: first period elements (H) in the periodic table have no more than 2 valence electrons, and second period elements (B, C, N, O, F) can never have more than 8 valence electrons.

But elements from the third period and further can have **expanded octets**, meaning that they have more than eight electrons around one atom. This is possible because the 3<sup>rd</sup>-shell can have a total of 18 electrons. To summarize:

- H will have max. 2 electrons in its valence shell = surrounded by 1 e<sup>-</sup>-pair
- B will oftentimes have only 6 electrons in its outer shell = 3 e<sup>-</sup>-pairs.
- C, N, O & F will *always* obey the octet rule.
- P, S, Cl, Br & I and other non-metal elements beyond the 3<sup>rd</sup> period prefer to have an octet, but can expand their octet to have up to 18 electrons in their valence shell.

## How to draw Lewis structures

- 1 → Calculate the total number of valence electrons → electron pairs.
  - derive the number of valence electrons from the group number of the element;
  - add the charge of anions or subtract the charge of cations.
- 2 → Draw the most likely structure of the molecule.
  - the central atom is usually the least electronegative atom;
  - refrain from drawing cyclic compounds, unless explicitly stated.
- 3 → Add lone pairs to the outer atoms, until each has an octet (or duets for H).
  - place remaining lone pairs on the central atom (expanded octet);
  - if the central atom has fewer electrons than an octet, exchange lone pairs from the outer atoms to form double or triple bonds to the central atom to achieve an octet;
  - resonance occurs when the double bond can be placed in multiple equivalent positions.
- 4 → Determine the formal charge (FC) on each atom separately.
  - formal charge = 0 when atoms have their *regular number of bonds*, e.g. H: 1 bond, C: 4 bonds, N: 3 bonds, O: 2 bonds, F: 1 bond etc.
  - formal charge = number of valence electrons -  $1 \times$  number of bonds -  $2 \times$  number of lone pairs
  - the formal charges should add up to the overall charge of the molecule or ion.
- 5 → Minimize formal charge by expanding the octet of the central atom.
  - to reduce the formal charge, exchange a lone pair to form a double/triple bond;
  - only elements from the third period and further can have an expanded octet.

Example

### Draw the Lewis structure of $\text{H}_3\text{O}^+$ .

- 1 → Number of valence electrons of O = 6 and H = 1.  
Also deduct one from the total due to the 1+ charge (it has one  $e^-$  less)
 
$$6 + 3 \cdot 1 - 1 = 8 \text{ ve}^-$$
 or 4  $e^-$ -pairs
- 2 → Draw the most likely structure of the molecule.  
H has lower electronegativity than O, but it cannot go in the center (can only make 1 bond)
 
$$\begin{array}{c} \text{H}-\text{O}-\text{H} \\ | \\ \text{H} \end{array}$$
- 3 → Make octets on the outer atoms (or duets on H) and add the remaining lone pair(s) to the central atom.
 
$$\begin{array}{c} \text{H}-\bar{\text{O}}-\text{H} \\ | \end{array}$$
- 4 → The formal charge of the H-atoms is 0 because each has 1 bond, oxygen has three bonds instead of two so the formal charge has to be calculated.
 
$$6 \text{ ve}^- - 3 \text{ bonds} - 2 \times 1 \text{ lone pair} = 1,$$
 so the formal charge of O is +.
 
$$\begin{array}{c} \text{H}-\overset{\oplus}{\text{O}}-\text{H} \\ | \end{array}$$

## Resonance structures

When multiple Lewis structures can be drawn that satisfy the above rules, electrons are **delocalised** which contributes to the stability of a molecule or polyatomic ion.

Example.

Draw the Lewis structure of  $O_3$  and show the resonance structures and the resonance hybrid.

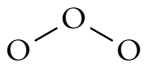
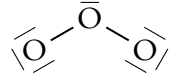
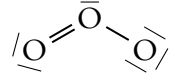
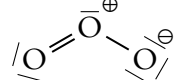
<p>1 →</p> <p>2 →</p> <p>3 →</p> <p>4 →</p> <p>5 →</p>	<p>The number of valence electrons of O = 6</p> <p>Draw the most likely structure of the molecule.</p> <p>Make octets on the outer atoms and add the remaining lone pair to the central atom.</p> <p>Form an octet on the central atom by exchanging a lone pair for a double bond.</p> <p>Determine the formal charge on each atom.</p> <p>The octet cannot be expanded.</p>	<p><math>3 \cdot 6 = 18ve^-</math> or <math>9 e^-</math>-pairs</p>    
--	---	---

In step 3 the placement of the double bond on the left or right of the central atom is arbitrary. The *real* structure of ozone has an electron distribution that is the mean of the two possible structures. When we draw both resonance structures we usually draw  $\longleftrightarrow$  in between the structures.

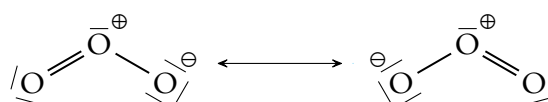

### 4.3.2 VSEPR: shapes of molecules and ions



**Electron domain** every bonding or non-bonding pair surrounding an atom. Single, double and triple bonds *count as 1 electron domain*, because they are situated between two atoms in the same 'spatial domain'

**VSEPR (Valence Shell Electron Pair Repulsion Theory)** electron domains arrange around the central atom to be as far apart from each other as possible.

The shape of molecules and ions can be predicted by accounting the number of electron domains. The geometry of the central atom is a contraction of the number of electron domains, and the number of bonding vs. non-bonding electron pairs. *To determine the shape of a molecule you must always first draw the Lewis structure!*

Non-bonding electron domains have a stronger repulsion than bonding-electron domains. When a molecule has a non-bonding pair, it pushes the bonding pairs slightly closer together, resulting in decrease of  $2.5^\circ$  per non-bonding pair.

Figure 4.1

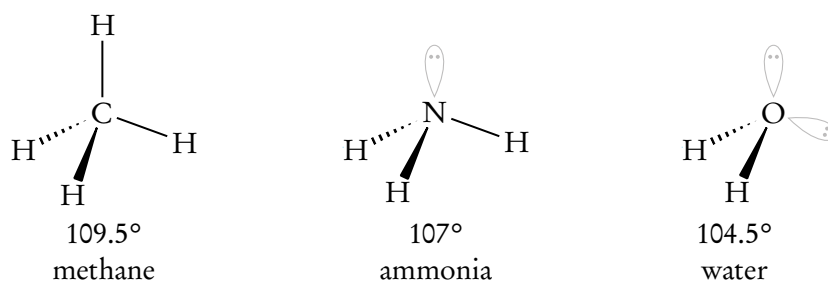



Methane, ammonia and water each have tetrahedral electron domain geometry. But with increasing number of lone-pairs, they have different molecular geometries.



**Electron domain geometry** the 3d arrangement of atoms *and* lone pairs.

**Molecular geometry** the 3d arrangement of *only* atoms.

In the table below the central atom is drawn as  and the surrounding atoms as . The lobe with two dots  represents a lone pair.

### 2 Electron Domains: linear ED geometry

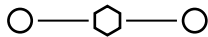
Bonding pairs	Non-bonding pairs	Name of the molecular shape (atoms only)	Bond angle	Molecular shape
2/4	0	linear	180°	

### 3 Electron Domains: trigonal planar ED geometry

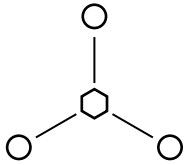
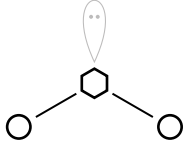
Bonding pairs	Non-bonding pairs	Name of the molecular shape (atoms only)	Bond angle	Molecular shape
3/4	0	planar triangular	120°	
2/3	1	bent / v-shape	117.5°	

## 4 Electron Domains: tetrahedral ED geometry

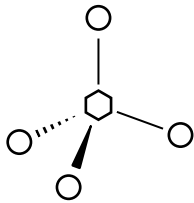
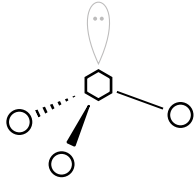
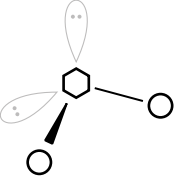
Bonding pairs	Non-bonding pairs	Name of the molecular shape (atoms only)	Bond angle	Molecular shape
4	0	tetrahedral	$109.5^\circ$	
3	1	trigonal pyramid	$107^\circ$	
2	2	bent / v-shape	$104.5^\circ$	

See chapter 3 for the definition of electronegativity

### Polar bonds: from covalent to ionic bonding

Ionic bonds form when atoms *transfer* electrons, covalent bonds form when atoms *share* electrons. If only life was that simple! In reality, electrons of many covalent bonds are not shared equally: elements with a greater **electronegativity (EN)** have a greater pull on the shared electron pair: resulting in a **polar bond**.

The element that has higher EN pulls  $e^-$  closer and so gains a partial negative charge ( $\delta^-$ ), leaving a slightly electron deficient atom with a partial positive charge ( $\delta^+$ ).

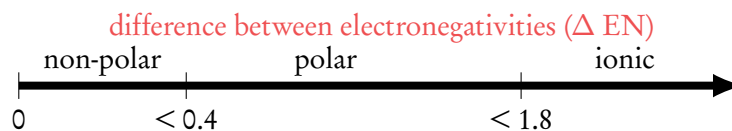

So the  $\Delta EN$  between two elements determines whether the bond will be:

- pure covalent:**  $\Delta EN \leq 0.4$  (approx. equal sharing)  
**polar covalent:**  $0.4 < \Delta EN \leq 1.8$  (unequal sharing)  
**ionic:**  $\Delta EN > 1.8$  (no longer sharing,  $e^-$  are transferred to form ions)

Whether a bond is covalent or polar covalent *inside* a molecule, determines the type of bonding *between* molecules  $\rightarrow$  intermolecular forces dictate the properties of molecular compounds.

## 4.4 Intermolecular forces

The physical properties of (simple) molecular compounds are determined by the bonding *between molecules*. There are three main types of bonding between molecules (= **intermolecular bonding**):

1. hydrogen bonding *(strongest & most polar)*
2. dipole-dipole bonding *(weaker & still polar)*
3. London dispersion forces *(weakest & non-polar)*



### 4.4.1 Hydrogen bonding



**Hydrogen bonding** a directional and medium strength bond between molecules that occurs when a molecule contains ( $-\text{OH}$ ,  $-\text{NH}_x$  or  $\text{HF}$ ).

When a H-atom is bound directly to a small very electronegative atom (O, N or F), the shared  $e^-$  pair is strongly pulled toward the electronegative atom. Since H has no inner shell electrons, the positive nucleus is exposed more than it would be for other elements. The larger unshielded charge allows the formation of hydrogen bonds.

The more H-bond forming groups a molecule has (relative to the size of the molecule), the more H-bonds can be formed and so the stronger the IMF, thus the higher MP/BP. This is illustrated in Table 4.1.

Table 4.1

	1,2-ethanediol	ethanol	1-propanol
Structure	$\begin{array}{c} \text{H} \quad \text{H} \\   \quad   \\ \text{HO}-\text{C}-\text{C}-\text{OH} \\   \quad   \\ \text{H} \quad \text{H} \end{array}$	$\begin{array}{c} \text{H} \quad \text{H} \\   \quad   \\ \text{H}-\text{C}-\text{C}-\text{OH} \\   \quad   \\ \text{H} \quad \text{H} \end{array}$	$\begin{array}{c} \text{H} \quad \text{H} \quad \text{H} \\   \quad   \quad   \\ \text{H}-\text{C}-\text{C}-\text{C}-\text{OH} \\   \quad   \quad   \\ \text{H} \quad \text{H} \quad \text{H} \end{array}$
BP	197.3 °C	78 °C	97 °C
MP	-12.9 °C	-114 °C	-126 °C

### 4.4.2 Dipole-dipole forces



**Dipole molecule** a molecule with asymmetrically distributed partial negative and positive charge

- Presence of a polar bond:  $\Delta \text{EN} > 0.4$
- Asymmetric distribution of  $\delta^+$  and  $\delta^-$

**Dipole-dipole bond** electrostatic attraction between the partial charges of two dipole molecules



**Ion-dipole bond** electrostatic attraction between an ion and the partial charge of a dipole molecule

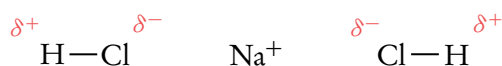

Identifying dipole molecules			
	H <sub>2</sub> O	H <sub>2</sub> CO	CO <sub>2</sub>
1. Draw the Lewis structure			
2. Polar bonds? ( $0.4 < \Delta EN < 1.8$ )	OH: $3.5 - 2.1 = 1.4$	CH: $2.5 - 2.1 = 0.4$ CO: $3.5 - 2.5 = 1.0$	CO: $3.5 - 2.5 = 1.0$
3. Draw the 3D molecule			
4. Geometric charge distribution?	No: dipole molecule	No: dipole molecule	Yes: not a dipole molecule

### Bond strength

Electrostatic attraction increases as the charge difference increases. So:

- ion-dipole > dipole-dipole > dipole-induced dipole
- polar bonds with larger  $\Delta EN >$  less polar bonds with smaller  $\Delta EN$

### 4.4.3 London (dispersion) forces

Never use the term 'van der Waals forces', which is a collective term for several forces, because the IB is very strict about naming the precise type of bonding that occurs.



**London Dispersion (LD) forces** electrons oscillate in all molecules, causing a temporary instantaneous dipole. This in turn can induce a temporary instantaneous dipole in a neighbouring molecule, resulting in a weak electrostatic attraction between the molecules

### Bond strength

The LD forces increase as the polarisability of molecules increases:

- as the number of electrons increases = the mass of a molecule increases.
- as the surface area of a molecule increases. Branched molecules have a smaller surface area, are less polarizable, so they experience smaller LD forces.

Heavier molecules tend to have more electrons, so it is common to say that the strength of the London dispersion forces increases with molecular mass.

	mass	BP
F <sub>2</sub>	38 u	-188 °C
Cl <sub>2</sub>	71 u	-34 °C
Br <sub>2</sub>	160 u	58 °C
I <sub>2</sub>	254 u	183 °C

	mass	BP
CH <sub>3</sub> -CH <sub>2</sub> -CH <sub>2</sub> -CH <sub>2</sub> -CH <sub>3</sub>	72 u	36 °C
	72 u	10 °C

## 4.5 Properties of molecular compounds

Note that the properties of simple molecular compounds are very different from giant covalent compounds. The properties of (simple) molecular compounds depends on the type of attractive forces *between* the molecules, in order of decreasing strength: hydrogen bonding > dipole-dipole > London dispersion forces.

	Propane	Ethanal	Ethanol
molar mass	44 g mol <sup>-1</sup>	44 g mol <sup>-1</sup>	46 g mol <sup>-1</sup>
structure	$\begin{array}{ccccccc} & \text{H} & \text{H} & \text{H} & & & \\ &   &   &   & & & \\ \text{H} & -\text{C} & -\text{C} & -\text{C} & -\text{H} & & \\ &   &   &   & & & \\ & \text{H} & \text{H} & \text{H} & & & \end{array}$	$\begin{array}{ccc} & \text{H} & \text{O} \\ &   & // \\ \text{H} & -\text{C} & -\text{C} \\ &   &   \\ & \text{H} & \text{H} \end{array}$ <p style="text-align: center;"><math>\delta^+</math>      <math>\delta^-</math></p>	$\begin{array}{ccccccc} & \text{H} & \text{H} & & & & \\ &   &   & & & & \\ \text{H} & -\text{C} & -\text{C} & -\text{O} & & & \\ &   &   &   & & & \\ & \text{H} & \text{H} & \text{H} & & & \end{array}$ <p style="text-align: center;"><math>\delta^+</math>      <math>\delta^-</math>      <math>\delta^+</math></p>
boiling point	-42.2 °C	20.8 °C	78.5 °C
bonding type	London dispersion	dipole-dipole London dispersion	hydrogen bonding dipole-dipole London dispersion
polarity	non-polar	polar	polar

### Melting-/boiling point

Comparing molecules of approximately the same molar mass (constant London dispersion forces); molecules that form hydrogen bonds will have highest MP/BP, then dipole molecules, then molecules that only experience LD forces.

*Note:* the weaker the intermolecular forces, the lower the MP/BP *and* the more volatile the substance.

### Malleability

Whether molecular compounds are malleable depends on the type, directionality and strength of intermolecular forces. Generally speaking, hydrogen bonds and giant covalent bonds are highly directional, so solids wherein these play a key-role are not malleable. Nevertheless, a huge range between brittle (e.g., glass) and malleable (e.g., clay) exists.

### Solubility

**Like tends to dissolve like:** so polar compounds dissolve well in polar solvents (e.g., water), and nonpolar compounds in nonpolar solvents (e.g., oil, hexane).

### Conduction

The requirements for conduction are that there are *charged particles* which *can move*. Molecular compounds are never charged, and so can never conduct electricity. (But ions that are dissolved in tap water can conduct electricity)

Tip: when asked what type of bonding is present *all* types must be given. So do not forget about LD-forces, as they are always present.

### 4.5.1 Giant covalent structures



**Giant covalent structures** all the atoms are bonded by covalent bonds in a continuous network extending throughout the material

**Allotropes** occur when an element can exist in different crystalline forms.

In a network solid there are no individual molecules, and therefore no *intermolecular* forces. The entire solid may be considered one big (macro)molecule. The chemical formula is the simplest ratios of the component atoms (**empirical formula**).

Examples of giant covalent structures are diamond and graphite (discussed below), Si (which is like diamond) and SiO<sub>2</sub> known as silica and quartz. Since every O-atom is shared between two Si-atoms, we can say that every Si-atom is bonded to four halves of an O-atom; in other words that for every one Si-atom there will be two O-atoms.

Structure of SiO<sub>2</sub>

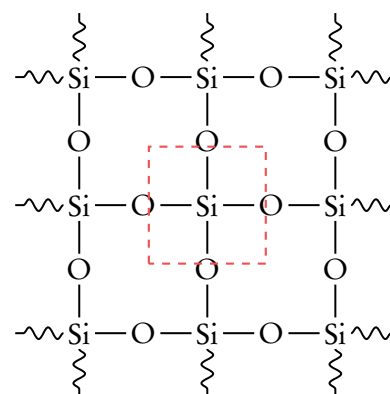

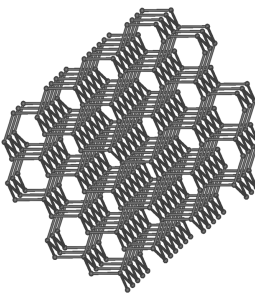
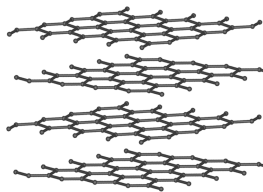
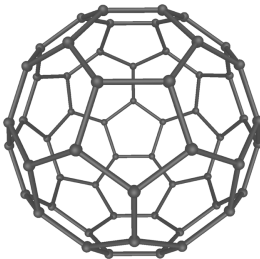
allotropes of C	Diamond	Graphite	Fullerene
			
<b>macrostructure</b>	network	stacked flat layers of hexagonal C lattices	hexagonal C lattice folded in on itself
<b>shape</b>	tetrahedral	trigonal planar	trigonal planar
<b>bond angles</b>	109.5°	120°	< 120°
<b>bonds</b>	single bonds	1 × double bond	1 × double bond
<b>hybridisation</b>	sp <sup>3</sup>	sp <sup>2</sup>	sp <sup>2</sup>
<b>conduction</b>	no, e <sup>-</sup> cannot move	yes, delocalised e <sup>-</sup> can move between layers	yes, delocalised e <sup>-</sup> can move over surface

# ENERGETICS



**Temperature  $T$**  a measure of the average kinetic energy of particles in a substance  
(= independent of the amount of substance)

**Heat  $Q$**  the amount of thermal energy in a given amount of substance  
(= proportional to the amount of substance)

Heat is a form of energy exchange, its direction depends on the difference in temperature. Heat flows from a warmer to a cooler substance.

**Enthalpy  $H$**  the amount of chemical potential energy contained in one mol of a substance, stored in its chemical bonds.

**Higher enthalpy:** substance has weaker bonds, can release more heat. | **Lower enthalpy:** substance has stronger bonds, can release less heat.

The absolute value of enthalpy cannot be measured, so we measure the *enthalpy change* ( $\Delta H$ ) between products and reactants in  $\text{kJ mol}^{-1}$ .

Read "enthalpy" as "chemical energy"

## Enthalpy: chemical potential energy

Chemical energy is a form of potential energy, like gravitational potential energy. Falling from a height of 8 km is deadlier than falling from 1 m, since a lot of gravitational potential energy is converted into kinetic energy.

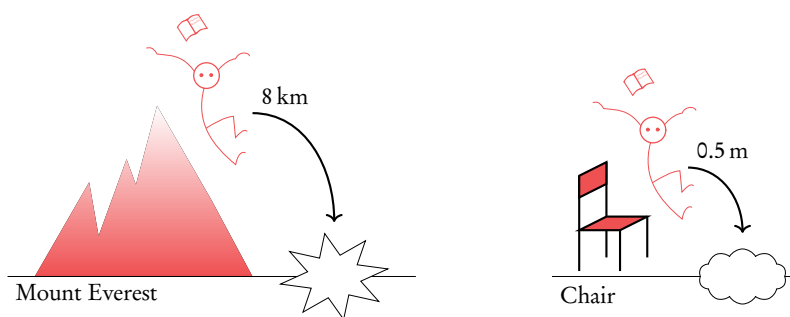

Although the stickman on top of the mountain has a huge amount of potential energy, this has no effect on the amount of his kinetic energy at the top. The kinetic energy (of his fall) depends on the *height difference*.

The amount of heat released or absorbed by a chemical reaction depends on the *height difference* between the initial and final enthalpy. Importantly, the average kinetic energy (temperature) of a system does not depend on the amount of enthalpy!

## Chemical system and the surrounding

It is important to make the distinction between a *chemical system* and its *surroundings*. The system consists of a chemical reaction: breaking chemical bonds requires energy (thus cooling the surrounding), while forming chemical bonds releases energy (thus heating the surrounding). Energy is exchanged between the system and its surrounding.

In other words, *enthalpy* ( $H$ ) can be converted into *heat* ( $Q$ ), and vice versa. The heat increase is equal to the enthalpy decrease.

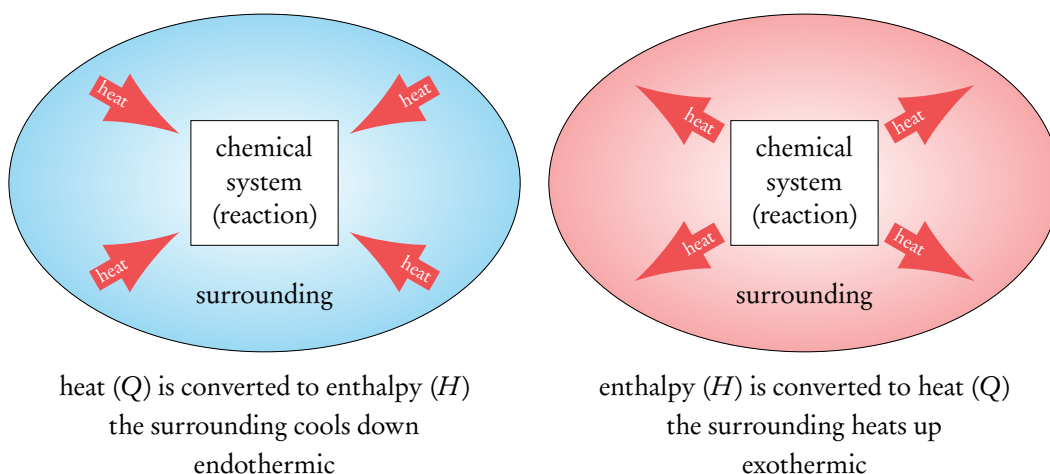

## Measuring enthalpy: calorimetry

To accelerate a train requires much more energy than a pedestrian. Similarly, different substances require different amounts of energy to increase their temperature by 1 K. To increase the temperature of 1 kg of water by 1 K requires 4.18 kJ, while iron would require ten times less energy (0.412 kJ).

Note that a temperature change of 1 K corresponds to a change of 1 °C

**Specific heat capacity ( $c$ )** the amount of heat in kJ (or J) to increase the temperature of 1 kg (or 1 g) of substance by 1 K.

Note that the temperature can *always* be input as either K or °C in *this* expression, but that mass in kg yields kJ, while g will yield J.

The change in the amount of heat is given by:

$$\Delta Q = cm\Delta T$$

$\Delta Q$ = heat change	[kJ]	or [J]
$c$ = specific heat cap.	[kJ kg <sup>-1</sup> K <sup>-1</sup> ]	or [J g <sup>-1</sup> K <sup>-1</sup> ]
$m$ = mass	[kg]	or [g]
$\Delta T$ = temperature change	[K] or [°C]	

In order to measure the enthalpy change of a chemical reaction, we can measure the equal but opposite heat change of the surroundings. We assume that all the heat released or used by a chemical reaction is used to change the temperature of the surroundings (no heat loss). Furthermore, enthalpy is defined per mol reactant resulting in the following expression:

$$\Delta H = -\frac{\Delta Q_{\text{surrounding}}}{n_{\text{system}}}$$

$\Delta H$	= enthalpy change [kJ mol <sup>-1</sup> ]
$\Delta Q_{\text{surrounding}}$	= heat change [kJ]
$n_{\text{system}}$	= mole amount [mol]

Note: convert heat to kJ before using this expression, since the databook and the exam will always use kJ mol<sup>-1</sup> as units for the enthalpy change.

Calorimetry is a technique to measure the increase or decrease in heat by measuring the temperature change of the surrounding, typically that of water ( $c = 4.18 \text{ J g}^{-1} \text{ K}$ ). Under the assumption that no heat is lost, the enthalpy change of a chemical reaction can be calculated from its effect on the temperature of its surrounding.

### Calorimetry: aqueous reaction

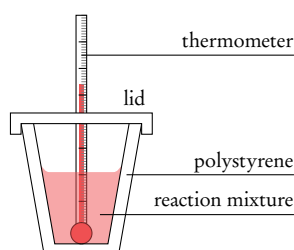

The temperature change caused by a chemical reaction in aqueous solution is measured. Assume that all heat is transferred to the water.

### Calorimetry: combustion

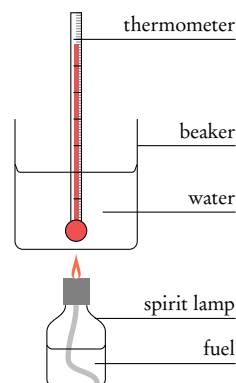

Assume that all the heat that is released by the combustion reaction is absorbed by the water.

Example.

### Determine $\Delta T$ from a graph

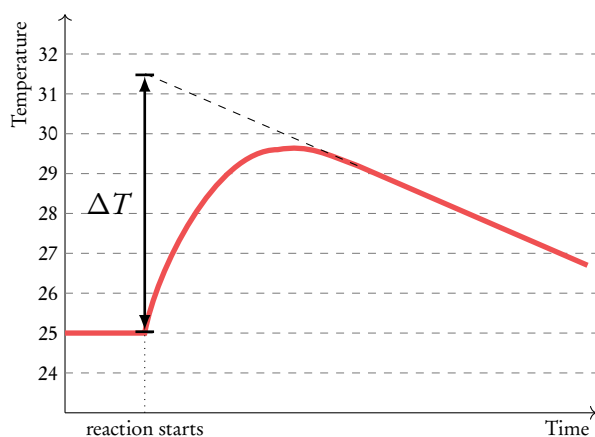

Extrapolate the graph *up to the point when the reaction starts*. This point represents the maximum temperature if the reaction had been instantaneous (no heat loss).

$$\begin{aligned} \Delta T &= T_{\text{end}} - T_{\text{start}} \\ &= 31.5^\circ\text{C} - 25.0^\circ\text{C} \\ &= 6.5^\circ\text{C} \end{aligned}$$

### Calculate the enthalpy change $\Delta H$ , when the temperature change $\Delta T$ of the surrounding is given

Calculate the enthalpy of combustion for  $P_4$  from the given data:

Mass of water	g	150.00
Initial temperature	$^{\circ}\text{C}$	25.0
Final temperature	$^{\circ}\text{C}$	31.5
Mass of phosphorus burned	g	0.0500

1. Calculate number of moles of the limiting reactant

$$n(P_4) = \frac{m(P_4)}{M(P_4)} = \frac{0.0500 \text{ g}}{4 \times 30.97 \text{ g mol}^{-1}} = 4.04 \times 10^{-4} \text{ mol}$$

2. Calculate heat change ( $\Delta Q$ ) of the surrounding

The temperature of the water changes:

$$\Delta Q = cm\Delta T = 4.18 \cdot 150.00 \cdot (31.5 - 25.0) = 4.08 \times 10^3 \text{ J} = 4.08 \text{ kJ}$$

3. Use these two values to calculate  $\Delta H$ . Convert to kJ first, and invert the sign

$$\Delta H = -\frac{\Delta Q}{n(P_4)} = -\frac{4.08 \text{ kJ}}{4.04 \times 10^{-4} \text{ mol}} = -1.01 \times 10^4 \text{ kJ mol}^{-1}$$

The reaction is exothermic since  $\Delta H = \text{negative}$ , which is logical because all combustion reactions are exothermic

## 5.2 Energy diagrams

A chemical reaction can use heat from the surrounding ( $T \downarrow$ ) to break bonds in the system (increasing enthalpy). Or the opposite, release heat to the surrounding ( $T \uparrow$ ) when bonds are formed (decreasing enthalpy).

In typical chemical reactions both processes occur: bonds are broken and new bonds are formed. And like your bank account, at the end of the month your balance will have increased or decreased by some net amount. When the net amount of enthalpy decreases (heat increases) a reaction is said to be exothermic, and when the net amount of enthalpy increases (heat decreases) a reaction is endothermic.



**Exothermic reaction** heat is released by reaction to the surroundings ( $T \uparrow$ ), the enthalpy  $H$  decreases or  $\Delta H < 0$ .

**Endothermic reaction** heat is used by reaction from the surroundings ( $T \downarrow$ ), the enthalpy  $H$  increases or  $\Delta H > 0$ .



## Diagrams

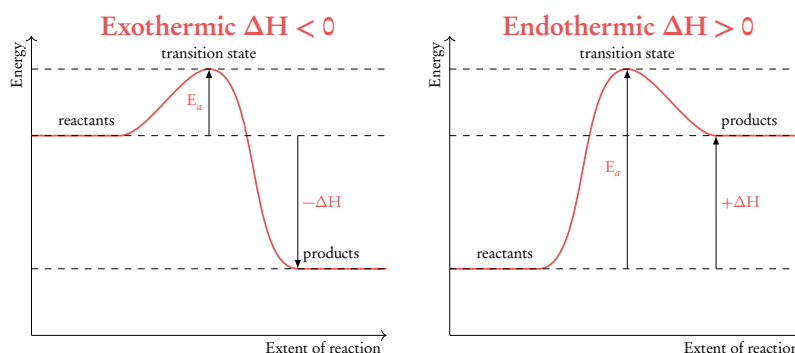

Sign of $\Delta H$	– (negative)	+ (positive)
Enthalpy $\Delta H$	decreases	increases
Heat $\Delta Q$	increases	decreases
Temperature $T$	increases	decreases
Bond strength	bonds in products are stronger than the bonds in the reactants	bonds in products are weaker than the bonds in the reactants
Typical examples	bond formation, combustion, acid/base neutralisation, ...	bond breaking, ionization (!), ...

## 5.3 Hess's law



**Hess's law** the enthalpy change ( $\Delta H$ ) of a reaction depends only on the difference between the enthalpy of the products and reactants, it is independent of the reaction pathway.

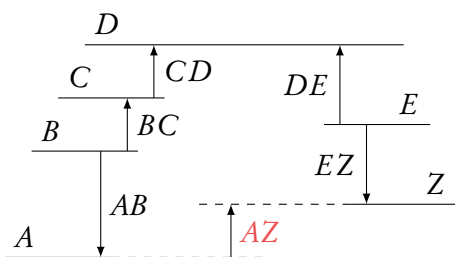

Figure 5.1

The elevation difference  $AZ$  equals the sum of all the individual distances from  $A$  to  $Z$ . Starting at  $A$ , let's walk over the diagram to  $Z$  via the levels  $B$ ,  $C$ ,  $D$ , and  $E$ .

$$AZ = -AB + BC + CD - DE + EZ$$

So whenever an arrow is in the wrong direction simply change the sign to reverse the arrow in the correct direction.

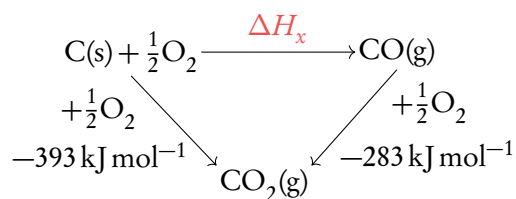

Figure 5.2

The diagram above in Figure 5.2 shows a typical exam question. To calculate  $\Delta H_x$ , start on the reactant side (left) and take the long route (via  $\text{CO}_2$ ) in the direction of the product (right). Flip the direction of the arrows by changing the sign of the values.

$$\begin{aligned}\Delta H_x &= -394 \text{ kJ mol}^{-1} + 283 \text{ kJ mol}^{-1} \\ &= -111 \text{ kJ mol}^{-1}\end{aligned}$$

Another typical application of Hess's law on the exam is when multiple component reaction equations and their corresponding  $\Delta H$  values are given, and you have to calculate the enthalpy change of a reaction that is a composite of the component reactions.

### Enthalpy change from component reactions

Consider the following equations:

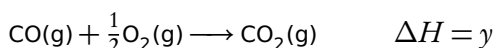
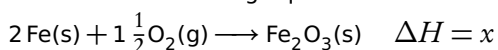

What is the enthalpy change of the overall reaction below?

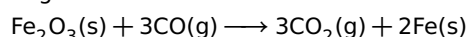

1.	Identify the unique compounds in the given reaction equations	In the first reaction Fe and $\text{Fe}_2\text{O}_3$ , and in the second CO and $\text{CO}_2$ .
2.	Are the unique compounds on the same side as in the overall reaction?	Fe and $\text{Fe}_2\text{O}_3$ are on the opposite sides in the overall reaction. So we invert: $\text{Fe}_2\text{O}_3\text{(s)} \longrightarrow 2\text{Fe(s)} + 1\frac{1}{2}\text{O}_2\text{(g)} \quad \Delta H = -x$
3.	Do the unique compounds have the correct reaction coefficients?	CO and $\text{CO}_2$ have coefficients 3 in the overall reaction. Multiply by three: $3\text{CO(g)} + 1\frac{1}{2}\text{O}_2\text{(g)} \longrightarrow 3\text{CO}_2\text{(g)} \quad \Delta H = 3y$
4.	Add the $\Delta H$ values to get the $\Delta H$ value of the overall reaction	$\Delta H = -x + 3y$

### Enthalpy change from component reactions

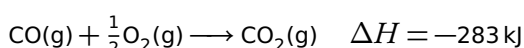
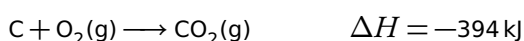

Calculate the enthalpy change using the given data for:  $\text{C(s)} + \text{O}_2\text{(g)} \longrightarrow \text{CO(g)}$

1.	Identify the unique compounds in the component equations	C in the first, CO in the second reaction.
2.	Are the unique compounds on the same side as in the overall reaction?	C is on the correct side, CO on the wrong side so invert the equation: $\text{CO}_2\text{(g)} \longrightarrow \text{CO(g)} + \frac{1}{2}\text{O}_2\text{(g)} \quad \Delta H = 283 \text{ kJ}$
3.	Do the unique compounds have the correct reaction coefficients?	Yes they already do, so do nothing
4.	Add the $\Delta H$ values to get the $\Delta H$ value of the overall reaction	$\Delta H = -394 \text{ kJ} + 283 \text{ kJ} = -111 \text{ kJ}$

### 5.3.1 Standard enthalpy of formation



**Standard state (symbol =  $\ominus$ )** is the most stable state of an element or compound under the standard conditions (pressure 100 kPa, temperature 298 K)

**(Standard) enthalpy of formation  $H_f^\ominus$**  the enthalpy change when *one mole* of a substance is formed *from its elements in their standard states* (at *standard conditions*).

**$H_f^\ominus = 0$  for:** elements in their standard state (e.g.  $C_{\text{graphite}}(s)$ ,  $Fe(s)$ ,  $O_2(g)$ , ...)

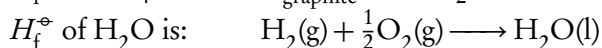
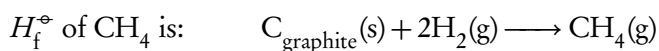

Enthalpy of formation is defined identically, just not specifically from their *standard states*

Figure 5.3 shows the standard enthalpy of formation for  $NO_2$  on the left, and  $N_2O_2$  in the middle. On the right we see the composite energy diagram for the reaction  $2NO_2 \longrightarrow N_2O_4$ .

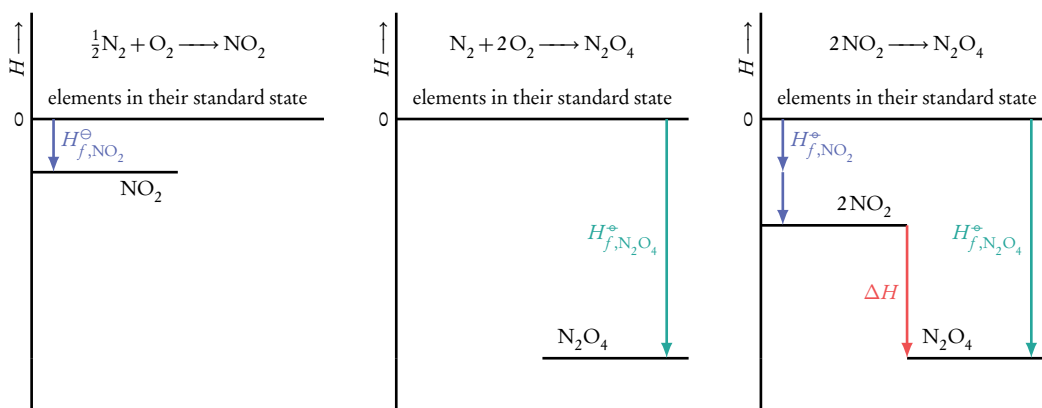

Figure 5.3

Using Hess's law (invert reactant side):  $\Delta H = \sum H_{f,\text{products}}^\ominus - \sum H_{f,\text{reactants}}^\ominus$

## 5.3.2 Bond enthalpy



Bond breaking is always endothermic

All compounds *must* be in the gaseous state

$\text{CH}_4 \rightarrow \text{CH}_3 + \text{H}$   
requires  $435 \text{ kJ mol}^{-1}$ ,  
 $\text{CH}_3 \rightarrow \text{CH}_2 + \text{H}$   
requires  $444 \text{ kJ mol}^{-1}$ .  
So instead we take  
1/the number of bonds  
in the molecule.

(Average) bond enthalpy  $H_b$  is the amount of energy required to break *one mole* of the *same type of bond*, in the gaseous state, (averaged over a variety of *similar compounds*.)

$H_b = 0$  for: free gaseous atoms (e.g.  $\text{H(g)}$ ,  $\text{C(g)}$ ,  $\text{Fe(g)}$ ,  $\text{O(g)}$ , ...)

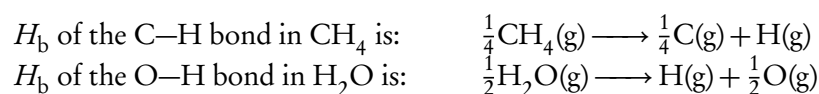

Figure 5.4 shows the bond enthalpy of the reactants ( $\text{H}_2 + \text{F}_2$ ) on the left, and the product enthalpy (HF) is shown in the middle. On the right we see the composite energy diagram for the reaction  $\text{H}_2 + \text{F}_2 \rightarrow 2\text{HF}$ .

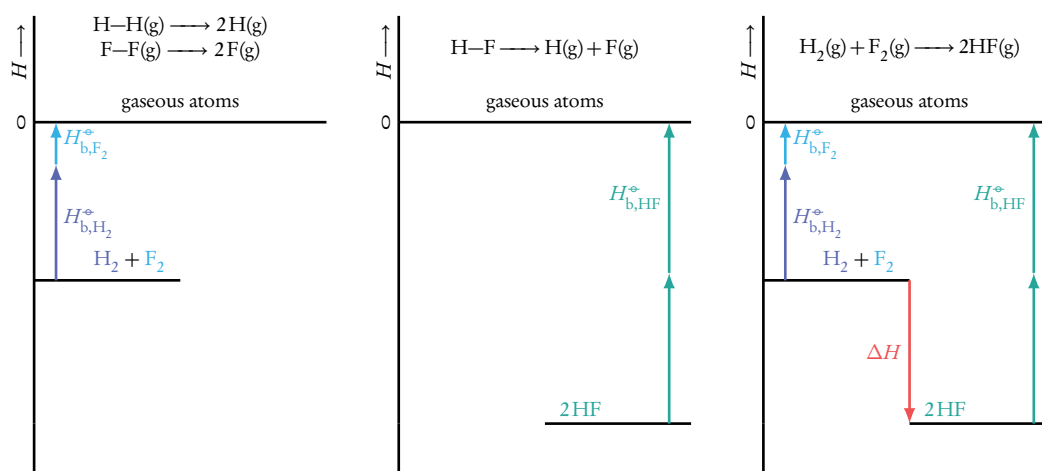

Figure 5.4

Using Hess's law (invert product side):  $\Delta H = \sum H_{b,\text{reactants}} - \sum H_{b,\text{products}}$

### Limitations of average bond enthalpies

- Bond enthalpies require that all compounds are in the gaseous state.
- Since average bond enthalpies are obtained by considering a number of similar compounds containing the type of bond in question, the bond energy in any particular compound may deviate.

### 5.3.3 Enthalpy of combustion



(Standard) enthalpy of combustion  $H_c^\ominus$  is the amount of energy released for the *complete combustion* of *one mole* of substance in its *standard state* and in *excess oxygen* (at *standard conditions*).

Combustion reactions are exothermic

$H_c^\ominus = 0$  for: complete combustion products under standard conditions (e.g.  $\text{CO}_2(\text{g})$ ,  $\text{H}_2\text{O}(\text{l})$ , ...)

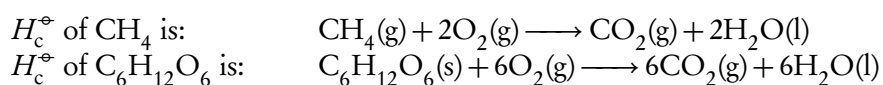

Figure 5.5 shows the combustion enthalpies of the reactants ( $\text{C}_2\text{H}_4 + \text{H}_2$ ) on the left, and the product ( $\text{C}_2\text{H}_6$ ) is shown in the middle. On the right we see the composite energy diagram for the reaction  $\text{C}_2\text{H}_4 + \text{H}_2 \longrightarrow \text{C}_2\text{H}_6$ .

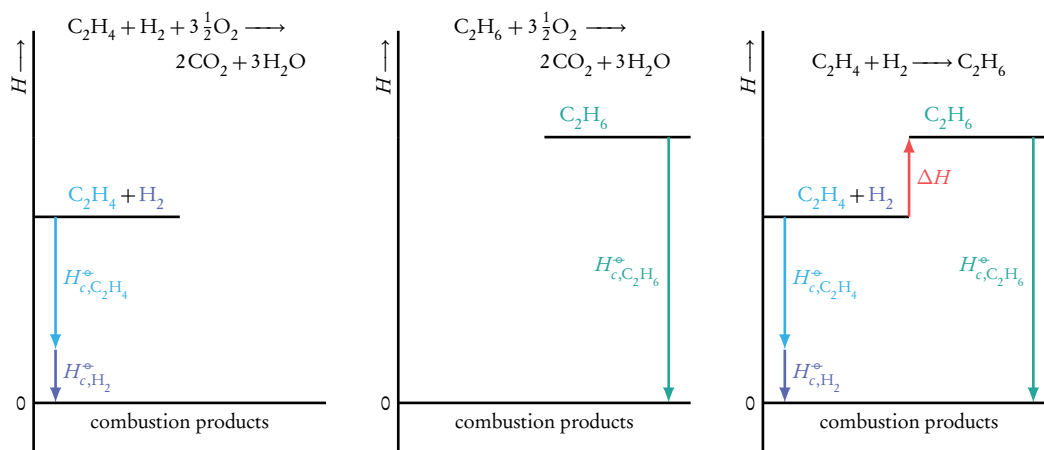

Figure 5.5

Using Hess's law (invert product side):  $\Delta H = \sum H_{c,\text{reactants}}^\ominus - \sum H_{c,\text{products}}^\ominus$

## 5.4 Energy calculations

Enthalpy calculations can be done by using either the enthalpy of formation, bond enthalpy *or* the enthalpy of combustion. Since enthalpy values are relative to  $H = 0$ , and this is different in all three cases, the three types of values cannot be used in *the same* calculation.

	Formation	Bond	Combustion
$H = 0$	elements at SATP	gaseous atoms	combustion products at SATP
<b>Definition</b>	forming <b>product</b>	breaking <b>reactant</b> bonds	burning <b>reactant</b>
$\Delta H =$	$\sum H_{f,\text{prod}}^{\ominus} - \sum H_{f,\text{react}}^{\ominus}$	$\sum H_{b,\text{react}}^{\ominus} - \sum H_{b,\text{prod}}^{\ominus}$	$\sum H_{c,\text{react}}^{\ominus} - \sum H_{c,\text{prod}}^{\ominus}$

### Calculate reaction enthalpy (formation)

Calculate the reaction enthalpy using the standard enthalpies of formation for:

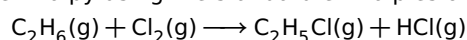

1.	Write the reaction equation	$\text{C}_2\text{H}_6(\text{g}) + \text{Cl}_2(\text{g}) \longrightarrow \text{C}_2\text{H}_5\text{Cl}(\text{g}) + \text{HCl}(\text{g})$				
2.	Find the enthalpy values (DB. 11-13) <i>remember: when is <math>H = 0</math>?</i>	<table style="margin-left: 20px;"> <tr> <td>-84</td> <td>0</td> <td>-137</td> <td>-92.3</td> </tr> </table>	-84	0	-137	-92.3
-84	0	-137	-92.3			
3.	Calculate $\sum H_{\text{reactant}}$ and $\sum H_{\text{product}}$ <i>separately</i>	<table style="margin-left: 20px;"> <tr> <td><math>\sum H_{\text{reactant}} = 1 \times -84 + 1 \times 0</math></td> </tr> <tr> <td><math>= -84 \text{ kJ}</math></td> </tr> <tr> <td><math>\sum H_{\text{product}} = 1 \times -137 + 1 \times -92.3</math></td> </tr> <tr> <td><math>= -229 \text{ kJ}</math></td> </tr> </table>	$\sum H_{\text{reactant}} = 1 \times -84 + 1 \times 0$	$= -84 \text{ kJ}$	$\sum H_{\text{product}} = 1 \times -137 + 1 \times -92.3$	$= -229 \text{ kJ}$
$\sum H_{\text{reactant}} = 1 \times -84 + 1 \times 0$						
$= -84 \text{ kJ}$						
$\sum H_{\text{product}} = 1 \times -137 + 1 \times -92.3$						
$= -229 \text{ kJ}$						
4.	Use the correct formula for $\Delta H =$ <b>formation:</b> $\sum H_{f,\text{prod}} - \sum H_{f,\text{react}}$ <b>bond/combustion:</b> $\sum H_{\text{react}} - \sum H_{\text{prod}}$	<table style="margin-left: 20px;"> <tr> <td><math>\Delta H = \sum H_{f,\text{product}} - \sum H_{f,\text{reactant}}</math></td> </tr> <tr> <td><math>= -229 - -84 \text{ kJ mol}^{-1}</math></td> </tr> <tr> <td><math>= -145 \text{ kJ mol}^{-1}</math></td> </tr> </table>	$\Delta H = \sum H_{f,\text{product}} - \sum H_{f,\text{reactant}}$	$= -229 - -84 \text{ kJ mol}^{-1}$	$= -145 \text{ kJ mol}^{-1}$	
$\Delta H = \sum H_{f,\text{product}} - \sum H_{f,\text{reactant}}$						
$= -229 - -84 \text{ kJ mol}^{-1}$						
$= -145 \text{ kJ mol}^{-1}$						

When calculating  $\sum H$  remember to multiply the enthalpy values with the reaction coefficients  
 $\times$  number of molecules

### Calculate reaction enthalpy (bond)

Calculate the reaction enthalpy using the bond enthalpies for:

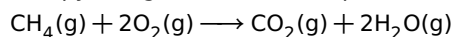

1. Write the reaction equation  
in structural formulas

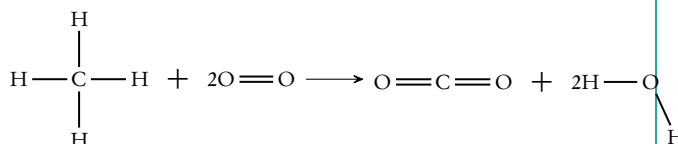

2. Find the enthalpy values  
(DB. 11-13)



3. Calculate  $\sum H_{\text{reactant}}$  and  
 $\sum H_{\text{product}}$  separately

$$\begin{aligned} \sum H_{\text{reactant}} &= 4 \times 414 + 2 \times 498 \\ &= 2652 \text{ kJ} \\ \sum H_{\text{product}} &= 2 \times 804 + 2 \times 2 \times 463 \\ &= 3460 \text{ kJ} \end{aligned}$$

× bonds per molecule  
× number of molecules

4. Use the correct formula for  
 $\Delta H =$

$$\begin{aligned} \Delta H &= \sum H_{\text{b,reactant}} - \sum H_{\text{b,product}} \\ &= 2652 - 3460 \text{ kJ mol}^{-1} \\ &= -808 \text{ kJ mol}^{-1} \end{aligned}$$

### Calculate reaction enthalpy (combustion)

Calculate the reaction enthalpy using the standard enthalpies of combustion for:

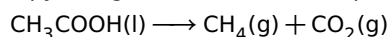

1. Write the reaction equation

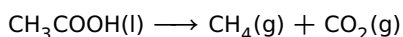

2. Find the enthalpy values (DB. 11-13)  
remember: when is  $H = 0$ ?

-874	-891	0
------	------	---

$\text{CO}_2$  is a product of  
complete combustion,  
so  $H_c^\ominus = 0$

3. Calculate  $\sum H_{\text{reactant}}$  and  $\sum H_{\text{product}}$   
separately

$$\begin{aligned} \sum H_{\text{reactant}} &= 1 \times -874 \\ &= -874 \text{ kJ} \\ \sum H_{\text{product}} &= 1 \times -891 + 1 \times 0 \\ &= -891 \text{ kJ} \end{aligned}$$

× number of molecules

4. Use the correct formula for  $\Delta H =$   
**formation:**  $\sum H_{\text{f,prod}} - \sum H_{\text{f,react}}$   
**bond/combustion:**  $\sum H_{\text{react}} - \sum H_{\text{prod}}$

$$\begin{aligned} \Delta H &= \sum H_{\text{c,reactant}} - \sum H_{\text{c,product}} \\ &= -874 - -891 \text{ kJ mol}^{-1} \\ &= 17 \text{ kJ mol}^{-1} \end{aligned}$$





# KINETICS



**Reaction rate** the change in concentration of a particular reactant or product per unit time, measured in  $\text{mol dm}^{-3} \text{s}^{-1}$

$$\text{rate} = -\frac{\Delta[\text{reactants}]}{\Delta t} = \frac{\Delta[\text{products}]}{\Delta t}$$

In a concentration vs. time graph, which shows the progress of a chemical reaction, the reaction rate is equal to the tangent or slope. When the slope = 0 (the graph is horizontal) the reaction has reached either completion or equilibrium.

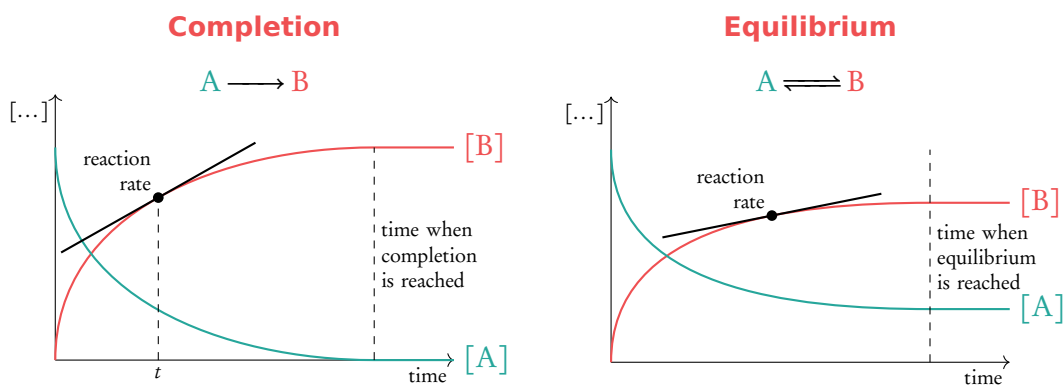

## Experimental determination

The rate of reaction can be experimentally determined by measuring how the concentration *changes* with time. Multiple concentration measurements have to be performed over time to infer the rate from the change. To measure concentration we can:

- use an absorption spectrometer; absorption is stronger with a higher concentration (of for example coloured transition metals complexes)
- measure the pH if the  $[\text{H}^+]$  or  $[\text{OH}^-]$  concentrations change
- measure the electrical conductivity if the ionic concentration changes
- measure the volume of a gas (which is proportional to the amount in mole) that is evolved from reaction
- measure the mass change of the sample as a result of gas formation.

## 6.1 Collision Theory

Collision theory states the three conditions that must be met for a successful reaction to take place:

Collision theory	increase rate
1 particles must collide,	higher collision frequency
2 with proper orientation,	—
3 and sufficient energy	increase collision energy (by increasing $T$ ), lower energy barrier ( $E_a$ )

The collision theory can be used to understand how the rate of reaction can be affected. Every collision with proper orientation and with sufficient energy leads to a chemical reaction (known as **effective collisions**). When more collisions occur per second (*higher collision frequency*), there is a proportional increase in the number of effective collisions. Also, by either increasing the collision energy or lowering the energy barrier, a *larger fraction* of the collisions are effective. The orientation of collisions is random and cannot be influenced.

or decrease by doing the opposite

The four factors that increase the rate of reaction:

1. **↑ concentration/pressure:** particles are closer together so the *collision frequency* will increase.
2. **↑ surface area / ↓ particle size:** collisions with solids occur on the surface, so increasing the surface area will increase the *collision frequency*.
3. **↑ temperature:** particles have a higher amount of average kinetic energy, resulting in an increase in the *collision frequency* **and** a *larger fraction* of the collisions will be effective by increasing the collision energy.
4. **add catalyst:** provides an alternative reaction pathway/mechanism which has a lower activation energy, so a *larger fraction* of the collisions will be effective.

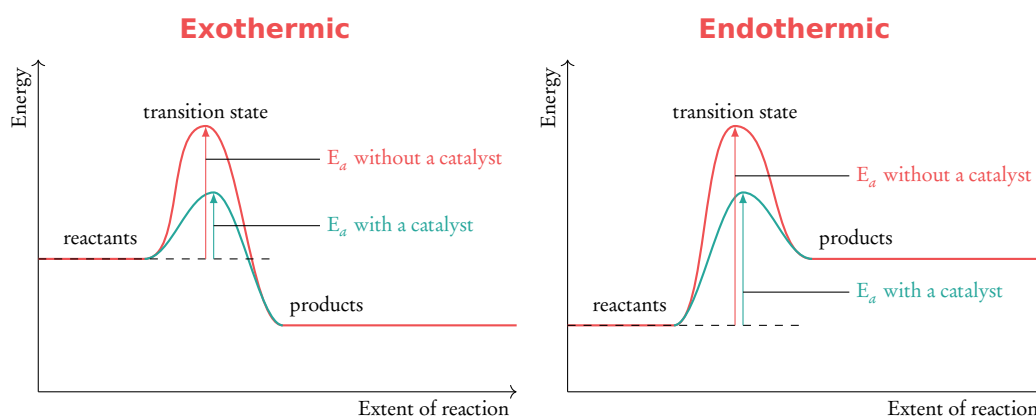

The activation energy ( $E_a$ ) is the minimum amount of energy of a collision between two particles to lead to a reaction. We can say: the energy required for an effective collision.

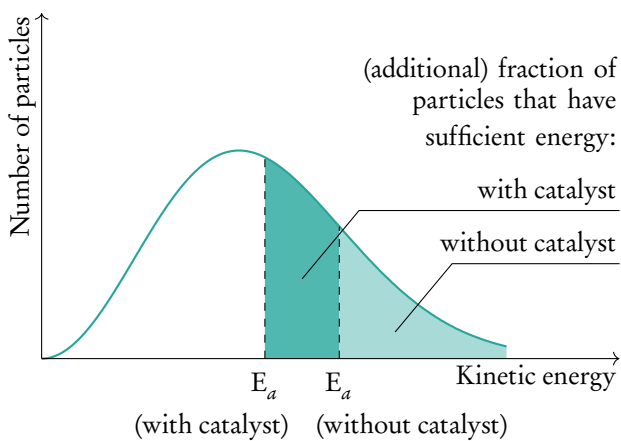
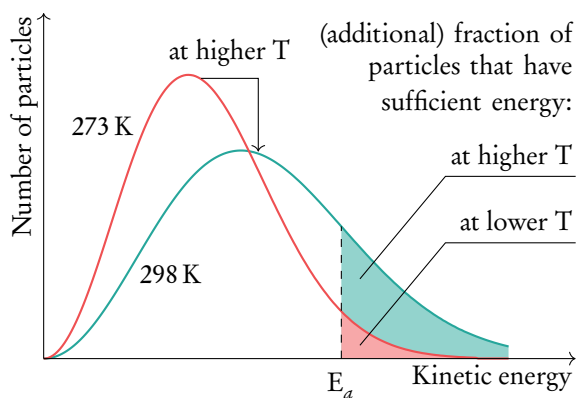



# EQUILIBRIUM

## 7.1 Dynamic equilibrium

In a static equilibrium nothing changes, like for example in a mass balance. Chemical equilibria are dynamic, there is a constant conversion in both directions such that there is no *net change*.



**Dynamic equilibrium** the *forward rate* of reaction equals the *reverse rate* of reaction.

Note that the *amounts* of reactants and products are not (necessarily) equal, the amounts are constant / do not change.

### Completion reaction

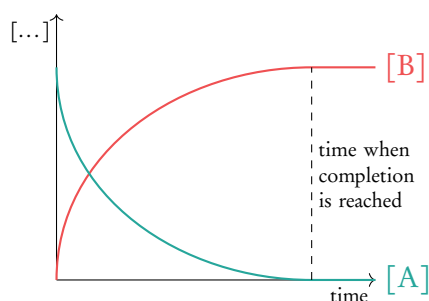
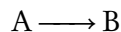

Reaction stops when the limiting reagent runs out.

### Equilibrium reaction

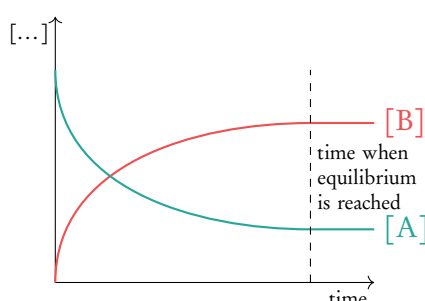
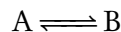

Reaction continues indefinitely but reaches equilibrium.

A system at equilibrium is a mixture with all of the reactants and products present\*, and the concentrations of the reactants and the products do not change. A consequence is that the macroscopic properties (the colour, viscosity etc.) of the system does not change. Systems can only remain in equilibrium in a closed system, since the exchange of matter with the surroundings would disturb the equilibrium.

\*remember: usually not in equal amounts!

## Understanding equilibriums

Using Collision Theory, we know that the reaction rate depends on the concentration. The forward reaction rate is proportional to the [reactant], and the reverse reaction rate is proportional to [product].

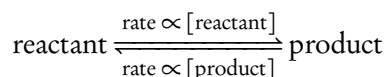

At the time that reagents are mixed ( $t = 0$ ) the forward reaction rate is greatest, but it decreases over time as the [reactant] decreases. At  $t = 0$  the reverse reaction rate is 0, as [product] = 0. But as [product] increases over time, so will the reverse reaction rate.

At equilibrium the forward reaction rate has decreased and the reverse reaction rate has increased to the point that they are *equal*. It does not matter from which side the equilibrium is approached, at some point the two rates will be equal.

## 7.2 Equilibrium law expression

Consider the generic chemical reaction given below, in which A + B react to form C + D and the reaction coefficients are indicated by the small letters  $pqr s$ .

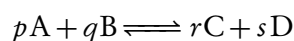

The reaction quotient  $Q$  is defined at any point in time during the reaction as:

$$Q = \frac{[C]^r \times [D]^s}{[A]^p \times [B]^q} = K_c \quad \text{or abstractly as} \quad \frac{[\text{products}]}{[\text{reactants}]}$$

Since the concentrations of the reactants and products do not change at equilibrium, the reaction quotient  $Q$  has a very specific value, which is called the **equilibrium constant**  $K_c$  (which *only* depends on temperature).

### Determine if a system is at equilibrium / predict direction of shift to restore equilibrium

Sulphur dioxide reacts with oxygen forming sulphur trioxide in an equilibrium reaction. At the prevailing temperature all substances are gaseous and  $K_c = 2$ . At some point in time, the concentrations are  $[\text{SO}_2] = 2 \text{ M}$ ,  $[\text{O}_2] = 1 \text{ M}$  and  $[\text{SO}_3] = 2 \text{ M}$ . Determine if the system is at equilibrium and predict direction of the shift to restore equilibrium.

1.	Write down the balanced equilibrium reaction.	$2\text{SO}_2(\text{g}) + \text{O}_2(\text{g}) \rightleftharpoons 2\text{SO}_3(\text{g})$
2.	Derive the reaction quotient $Q$ and calculate the result.	$Q = \frac{[\text{SO}_3]^2}{[\text{SO}_2]^2 \times [\text{O}_2]}$ $= \frac{2^2}{2^2 \times 1} = 1$
3.	When the equilibrium point is reached $Q = K_c$ .	Since $Q = 1$ at the given point in time, $Q \neq K_c$ , so the system is <i>not</i> in equilibrium.
4.	Use $Q = \frac{[\text{product}]}{[\text{reactant}]}$ . If $Q > K_c$ shift to reactant side and if $Q < K_c$ shift to product side.	Since $Q < K_c$ at the given point in time, to restore equilibrium the value of $Q$ should increase by increasing the $[\text{product}] / [\text{reactant}]$ , so the system is <i>not</i> in equilibrium.

$$\text{Magnitude of } K_c = \frac{[\text{products}]}{[\text{reactants}]}$$

If  $K_c$  has a very large value then the  $[\text{product}]$  must be much higher than the  $[\text{reactant}]$ .  
In summary for all values of  $K_c$ :

	reaction
$K_c \ll 1$	(almost) no reaction
$K_c < 1$	equilibrium favours reactant side
$K_c \approx 1$	approx. equal $[\text{reactant}]$ and $[\text{product}]$
$K_c > 1$	equilibrium favours product side
$K_c \gg 1$	tends to completion

## 7.3 States of matter

So far we've only considered chemical equilibria in closed systems, but similarly we can consider physical states of matter in closed systems. In particular: liquid-vapour equilibrium and precipitation-solution equilibrium of ionic compounds.

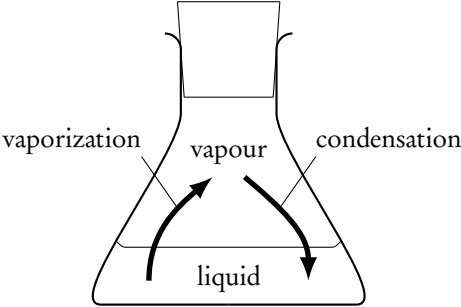
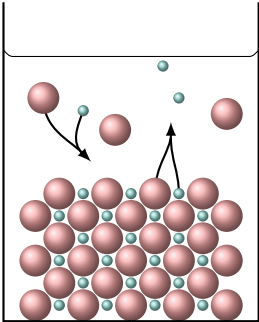
	Liquid vapour equilibrium	Solution equilibrium
<b>Equilibrium</b>	$\text{H}_2\text{O}(l) \rightleftharpoons \text{H}_2\text{O}(g)$	$\text{NaCl}(s) \rightleftharpoons \text{NaCl}(aq)$
<b>Drawing</b>		
<b>Explanation</b>	Fast moving particles will escape the liquid phase, evaporating into vapour phase. While slow moving particles condense into the liquid phase. When the rates of these processes are equal, a dynamic equilibrium will establish.	The ability of an ionic compound to dissolve depends on the rates of solution and precipitation, or in other words by the hydration vs. the lattice enthalpies. While table salt dissolves fully up to the point of saturation, the rates of solution and precipitation are at equilibrium after a solution is saturated.
<b>Independent of:</b>	<ul style="list-style-type: none"> <li>- Surface area: affects both evaporation and condensation</li> <li>- Volume of liquid in container</li> </ul>	<ul style="list-style-type: none"> <li>- Surface area: affects both solution and precipitation</li> <li>- Volume of solid in container</li> </ul>
<b>Dependent on:</b>	<ul style="list-style-type: none"> <li>- Volume of gas in container (concentration or partial pressure)</li> </ul>	<ul style="list-style-type: none"> <li>- Volume of liquid in container (concentration of dissolved particles)</li> </ul>



## 7.4 Le Chatelier's principle



Le Chatelier's principle states how a system that is in equilibrium responds to an external change.

**Le Chatelier's principle** when a system at equilibrium is disturbed by changing the conditions, the system will shift the position of equilibrium to (partially) counteract the change.

### Factors that affect the equilibrium position

The factors that affect the equilibrium position will be exemplified based on the following generic chemical reaction:

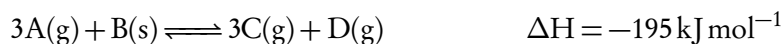

Stress	The position of the equilibrium will:	Example
increase [A]	shift away from A in order to lower [A]	to the product side
decrease [D]	shift towards D to partially restore its concentration	to the product side
increase P by a decrease in V	shift towards the side with fewer <b>gaseous</b> molecules to reduce the pressure	so to the reactant side
increase P by addition of an inert gas	no effect, because the partial pressures of the reactants and products do not change	—
add a catalyst	no effect, because the forward and reverse reaction rates are increased equally	—
increase T	shift toward the endothermic side (to lower the temperature) by <b>changing the value of <math>K_c</math></b>	to the reactant side, since the forward reaction is exothermic ( $\Delta H = -$ )



# ACIDS AND BASES

## 8.1 Acid and base definitions



Brønsted-Lowry	
<b>Acid</b>	H <sup>+</sup> donor
<b>Base</b>	H <sup>+</sup> acceptor
<b>Amphoteric</b>	H <sup>+</sup> donor & acceptor
<b>Amphiprotic</b>	H <sup>+</sup> donor & acceptor

An alkali is a base that is soluble in water.

**Conjugate acid/base pair** a pair of molecules that differ by a single H<sup>+</sup>-ion

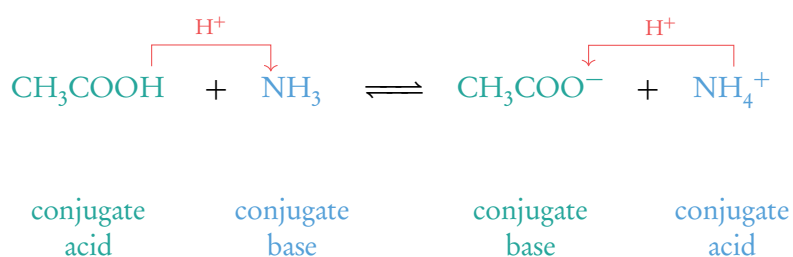

So the **conjugate base** is the species formed after the acid has donated a proton, and the **conjugate acid** is the species formed after the base has accepted a proton.

## 8.2 Strong vs weak



A proton in solution can be written as  $H^+$  or  $H_3O^+$ .

In solution, the  $[H_2O]$  barely changes due to the reaction, so we assume it stays constant.

**Strong acid/base** completely dissociates into its ion in aqueous solution

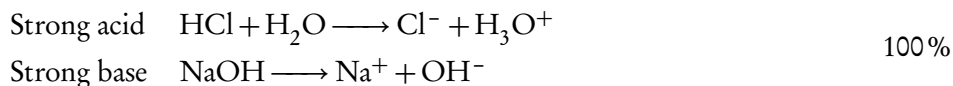

**Weak acid/base** dissociates partially into its ion in aqueous solution

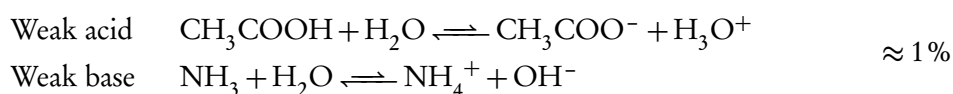

$$K_a = \frac{[CH_3COO^-][H_3O^+]}{[CH_3COOH][H_2O]} \quad K_b = \frac{[NH_4^+][OH^-]}{[NH_3][H_2O]}$$

### Common acids

### Common bases

<b>Strong</b>	HCl	hydrochloric acid			
	H <sub>2</sub> SO <sub>4</sub>	sulfuric acid			
	HNO <sub>3</sub>	nitric acid			
<b>Weak</b>	H <sub>3</sub> PO <sub>4</sub>	phosphoric acid	H <sub>2</sub> PO <sub>4</sub> <sup>-</sup>	dihydrogen phosphate	
	CH <sub>3</sub> COOH	ethanoic acid	CH <sub>3</sub> COO <sup>-</sup>	ethanoate	
	H <sub>2</sub> CO <sub>3</sub>	carbonic acid	HCO <sub>3</sub> <sup>-</sup>	hydrogen carbonate	<b>Weak</b>
	HCO <sub>3</sub> <sup>-</sup>	hydrogen carbonate	CO <sub>3</sub> <sup>2-</sup>	carbonate	
	CH <sub>3</sub> NH <sub>3</sub> <sup>+</sup>	methyl ammonium	CH <sub>3</sub> NH <sub>2</sub>	methane amine	
	NH <sub>4</sub> <sup>+</sup>	ammonium	NH <sub>3</sub>	ammonia	
		OH <sup>-</sup>	hydroxide		
		O <sup>2-</sup>	oxide	<b>Strong</b>	
		C <sub>2</sub> H <sub>5</sub> O <sup>-</sup>	ethoxide		

Any carboxylic acid is a weak acid, and the conjugate base (carboxylate) a weak base. Any amine is a weak base, and the conjugate acid (ammonium) a weak acid.

The strong bases occur on the exam as metal salts, such as NaOH, KOH, ... and Na<sub>2</sub>O, K<sub>2</sub>O, ...

## Experiments to distinguish strong and weak

The difference between strong and weak is the amount of dissociation into ions. An *equimolar* amount (!) of a strong acid will have a larger  $[\text{H}_3\text{O}^+]$  *than the same amount* of a weak acid. The same holds for bases, but then the strong base will have a larger  $[\text{OH}^-]$ .

1. **pH measurement** – strong acids have higher  $[\text{H}_3\text{O}^+]$  so the pH will be lower than that of a weak acid, and the reverse holds for strong bases. The pH can be measured with a digital pH meter, or with a (universal) indicator.
2. **Conduction measurement** – strong acids/bases dissociate fully into ions, so the conductivity of the solution will be much higher.
3. **Reaction rate** – strong acids have higher  $[\text{H}_3\text{O}^+]$ , so the reaction rate will be higher. For example: an equimolar amount of strong acid will produce a more vigorous reaction with a reactive metal than a weak acid.

Typical reactions of acids for which observations can be made include:

Reaction type	Example reaction	Observation
neutralisation	$2\text{HCl} + \text{Na}_2\text{O} \longrightarrow 2\text{NaCl} + \text{H}_2\text{O}$	exothermic, so the $T \uparrow$
metals (redox)	$2\text{HCl} + \text{Mg} \longrightarrow \text{MgCl}_2 + \text{H}_2$	$\text{H}_2(\text{g})$ bubbles
carbonate	$2\text{HCl} + \text{Na}_2\text{CO}_3 \longrightarrow 2\text{NaCl} + \text{CO}_2 + \text{H}_2\text{O}$	$\text{CO}_2(\text{g})$ bubbles
hydrogen carbonate	$\text{HCl} + \text{NaHCO}_3 \longrightarrow \text{NaCl} + \text{CO}_2 + \text{H}_2\text{O}$	$\text{CO}_2(\text{g})$ bubbles

## Important distinctions



**Strong** fully dissociated into ions

**Weak** partially dissociated to ions

**Concentrated** solution with a high concentration

**Dilute** solution with a low concentration

**Corrosive** highly reactive chemical

**TWO factors that affect the pH/pOH of a solution** the strength of the acid or base (strong vs weak) **AND** the concentration of the acid or base

A highly concentrated solution of a weak acid can easily be more acidic than a dilute solution of a strong acid.

## 8.3 pH scale



**pH** stands for **p**otential of **H**ydrogen, which is a scale to specify the acidity or basicity of an aqueous solution. The scale is logarithmic, so a change of **one unit in pH** represents a **10-fold change in concentration**.

**Formula to calculate p...**

$$\text{pH} = -\log[\text{H}_3\text{O}^+]$$

$$\text{pOH} = -\log[\text{OH}^-]$$

**Inverse to calculate [...]**

$$[\text{H}_3\text{O}^+] = 10^{-\text{pH}}$$

$$[\text{OH}^-] = 10^{-\text{pOH}}$$

**Neutral solution (at 298 K pH = 7)**

solution that contains equal amounts of  $\text{H}_3\text{O}^+$  and  $\text{OH}^-$

**Acidic solution (at 298 K pH < 7)**

solution that contains  $\text{H}_3\text{O}^+$  (more than  $\text{OH}^-$ )

**Alkaline solution (at 298 K pH > 7)**

solution that contains  $\text{OH}^-$  (more than  $\text{H}_3\text{O}^+$ )

Contrary to popular belief, the pH value can be less than 0 or greater than 14 for *strong and concentrated* acids and bases.

	pH	$[\text{H}_3\text{O}^+]$	$[\text{OH}^-]$	pOH	
	...	...	...	...	
acidic	-1	$10^1$	$10^{-15}$	15	acidic
	0	$10^0$	$10^{-14}$	14	
	1	$10^{-1}$	$10^{-13}$	13	
	...	...	...	...	
	6	$10^{-6}$	$10^{-8}$	8	
neutral	7	$10^{-7}$	$10^{-7}$	7	neutral
	8	$10^{-8}$	$10^{-6}$	6	
	...	...	...	...	
	13	$10^{-13}$	$10^{-1}$	1	
	14	$10^{-14}$	$10^0$	0	
alkaline	15	$10^{-15}$	$10^1$	-1	alkaline
	...	...	...	...	

So: +1 on the pH scale corresponds to a  $10\times$  larger  $[\text{H}_3\text{O}^+]$

## pH calculations: strong acids and bases

Calculate the pH of a  $0.500 \text{ mol dm}^{-3}$   $\text{Na}_2\text{O}$ -solution

- |    |   |  |
|----|---|--|
| 1. | Write the r.eq. of acid OR base <b>with <math>\text{H}_2\text{O}</math></b>   | $\text{Na}_2\text{O} + \text{H}_2\text{O} \longrightarrow 2 \text{Na}^+ + 2 \text{OH}^-$   |
| 2. | Use molar ratios to determine the $[\text{H}_3\text{O}^+]$ or $[\text{OH}^-]$ | The molar ratio of $\text{Na}_2\text{O} : \text{OH}^- = 1 : 2$ .<br>So: $[\text{OH}^-] = 2 \cdot 0.500 = 1.00 \text{ mol dm}^{-3}$ |
| 3. | Answer the question<br>(by using the pH formulas)                             | $\text{pOH} = -\log[\text{OH}^-]$<br>$= -\log 1.00 \text{ mol dm}^{-3} = 0.00$<br>$\text{pH} = 14.00 - 0.00 = 14.00$               |

## 8.4 Acid Deposition



**Acid deposition** acidic particles leave the atmosphere. 2 types: wet (acid rain) and dry (gaseous deposition)

**Regular rainwater** naturally acidic ( $\text{pH} = 5.6$ ) due to the presence of dissolved  $\text{CO}_2$

**Acid rain** made more acidic by  $\text{SO}_x$  and  $\text{NO}_x$  (fog, dew, snow, rain)

**Sources of  $\text{SO}_x$** 

- Volcanoes
- Combustion of S containing fossil fuels (coal, diesel, ...):

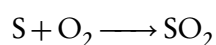
**Sources of  $\text{NO}_x$** 

- Electrical storms & bacteria
- Any combustion engine (air at high temperature and pressure):

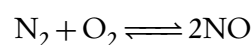
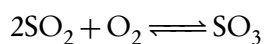
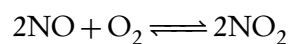
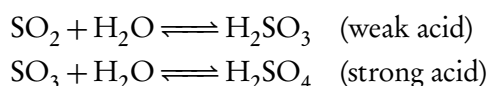
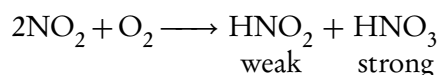
**Formation of  $\text{SO}_3$** **Formation of  $\text{NO}_2$** **Wet deposition****Wet deposition****Environmental effects**

Acid rain triggers a number of inorganic and biochemical reactions with detrimental environmental effects. To counteract its effects we should 1. Switch to alternative methods of energy production (not fossil fuels) and use less energy (e.g., public transport,

reduce consumption). And 2. reduce  $\text{SO}_x$  and  $\text{NO}_x$  production by cleaning exhaust gases using catalytic converters and removing S before, during and after combustion (scrubbing).

**Vegetation** The soil quality degrades because: 1. nutrients ( $\text{Mg}^{2+}$ ,  $\text{Ca}^{2+}$ , ...) are removed leading to stunted growth in plants and 2. poisonous  $\text{Al}^{3+}$  ions are discharged by chemical erosion of rocks, which damages the roots preventing the plants to take up water.

**Lakes & rivers** Acids damage mucous membranes, aquatic life (fish, snails, insect larvae) is very sensitive to pH. Lime  $\text{CaO}$  /  $\text{Ca}(\text{OH})_2$  is sometimes added to lakes to neutralise acidity. Additionally, the poisonous  $\text{Al}^{3+}$  ions that is discharged by chemical erosion of rocks is poisonous to fish.

**Human health** Acids also damage human mucous membranes, causing respiratory illnesses such as asthma, bronchitis, ...

**Buildings & structures** Marble and limestone consists of the insoluble  $\text{CaCO}_3$ , and the carbonate is a base which reacts with acid to form  $\text{CO}_2$  and soluble compounds:  
$$\text{CaCO}_3 + \text{H}_3\text{O}^+ \longrightarrow \text{Ca}^{2+} + \text{CO}_2 + \text{H}_2\text{O}.$$



# REDOX



**Oxidation** is loss of electrons, the reducing agent loses electrons.



Mg is oxidized (loss of  $e^{-}$ ),  
the oxidation state increases.

**Reduction** is gain of electrons, the oxidising agent gains electrons.

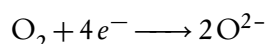

$\text{O}_2$  is reduced (gain of  $e^{-}$ ),  
the oxidation state decreases.

Since electrons are transferred in a redox reaction, you might think that the charges change. This is not always the case, instead the oxidation state changes:

**Oxidation state** hypothetical charge that an atom would have, if all bonds between different elements were 100% ionic (no covalent component).

Note that the oxidation state of, for example  $\text{Mg}^{2+}$ , is written as +2, while the charge is written as  $^{2+}$ .

**Redox reaction** reaction between an oxidising and a reducing agent, characterised by the transfer of electrons. In *all* redox reactions, the oxidation state of at least one atom changes.

Memorize: **OIL RIG**

**O**xidation  
**I**s  
**L**oss of electrons,  
**R**eduction  
**I**s  
**G**ain of electrons

Students are often flustered that the verb 'oxidised' and the nouns 'reducing agent' / 'reduced species' belong together.

Just remember that **OIL RIG** applies to the verb and the opposites are used for the nouns 'agent' / 'species'.

## 9.1 Oxidation states

Determine the oxidation state *per element* (!)

- 1 Elements *not combined with other elements* have oxidation number of 0.  
(e.g. Fe, Cu,  $\text{H}_2$ ,  $\text{O}_2$ ,  $\text{P}_4$ ,  $\text{S}_8$ , ...)
- 2 F when combined always has oxidation state of  $-1$ .
- 3 O *when combined* has oxidation state of  $-2$  except in peroxides.  
(e.g.  $\text{H}_2\text{O}_2$ ...when it is  $-1$ )
- 4 H *when combined* has oxidation state of  $+1$  except in metal hydrides.  
(e.g. LiH, NaH...when it is  $-1$ )
- 5 The oxidation state of ions in an ionic compound are equal to their charge.
- 6 The sum of all the oxidation states of a species equals the charge.

## What is the oxidation number of...

 ... Cl in  $\text{ClO}_4^-$ ?

$$\begin{array}{r} \text{Cl} = ? \\ 4 \times \text{O} = -8 \quad + \\ \hline \text{total} = 0 \end{array}$$

So the ox. state of Cl is +7.

 ... C in  $\text{H}_2\text{C}_2\text{O}_4$ ?

$$\begin{array}{r} 2 \times \text{H} = +2 \\ 2 \times \text{C} = ? \\ 4 \times \text{O} = -8 \quad + \\ \hline \text{total} = 0 \end{array}$$

So the ox. state of C is +3, since the two C atoms have to account for +6.

 ... P in  $\text{NaH}_2\text{PO}_3$ ?

$$\begin{array}{r} \text{Na} = +1 \\ 2 \times \text{H} = +2 \\ \text{P} = ? \\ 3 \times \text{O} = -6 \quad + \\ \hline \text{total} = 0 \end{array}$$

So the ox. state of P is +3.

## Identify which species are oxidised.

From the following reaction, deduce whether Zn is oxidised or reduced:

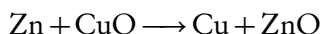

- |    |   |  |
|----|---|--|
| 1. | Is the element losing or gaining electrons? | ZnO is an ionic compound with zinc present as $\text{Zn}^{2+}$ . The Zn metal <i>loses</i> two electrons to form the $\text{Zn}^{2+}$ ion. |
| 2. | Apply 'OIL RIG'                             | Oxidation is loss, so Zn metal is oxidised.  |

## Identify which species is the oxidising or reducing agent.

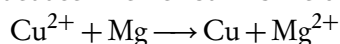
 From the following reaction, deduce whether  $\text{Cu}^{2+}$  is the oxidising or reducing agent:

- |    |  |   |
|----|--|---|
| 1. | Is the element losing or gaining electrons?                    | The $\text{Cu}^{2+}$ ion <i>gains</i> two electrons to form the Cu metal. |
| 2. | Apply 'OIL RIG'  | Reduction is gain, so $\text{Cu}^{2+}$ is reduced.                        |
| 3. | Reducing agents are oxidised, and oxidising agents are reduced | $\text{Cu}^{2+}$ is an oxidising agent.                                   |

## 9.2 Reactions



The overall balanced redox reaction can be derived from the oxidation and reduction half-reactions. A list of half-reactions can be found in databook table 24: “Standard electrode potentials at 298 K”.

**Half-reactions** are used to separate the oxidation and reduction parts of a redox reaction, useful as a tool to balance redox reactions.

### Balance redox reactions from the half-reactions.

An acidified potassium permanganate solution reacts with a copper coin. Write down the balanced redox reaction from the half-reactions.

- |    |   |  |
|----|---|--|
| 1. | Find both half-equations (DB 24).                 | $\text{MnO}_4^- + 8\text{H}^+ + 5e^- \longrightarrow \text{Mn}^{2+} + 4\text{H}_2\text{O} \quad   \times 2$ $\text{Cu} \longrightarrow \text{Cu}^{2+} + 2e^- \quad   \times 5$ |
| 2. | Balance $e^-$ by multiplying both half-reactions. | $2\text{MnO}_4^- + 16\text{H}^+ + 10e^- \longrightarrow 5\text{Mn}^{2+} + 20\text{H}_2\text{O}$ $5\text{Cu} \longrightarrow 5\text{Cu}^{2+} + 10e^-$                           |
| 3. | Add both half-reactions.                          | $2\text{MnO}_4^- + 16\text{H}^+ + 10e^- + 5\text{Cu} \longrightarrow$ $2\text{Mn}^{2+} + 8\text{H}_2\text{O} + 5\text{Cu}^{2+} + 10e^-$  |
| 4. | Cross out the same particles on both sides.       | $2\text{MnO}_4^- + 16\text{H}^+ + \cancel{10e^-} + 5\text{Cu} \longrightarrow$ $2\text{Mn}^{2+} + 8\text{H}_2\text{O} + 5\text{Cu}^{2+} + \cancel{10e^-}$                      |

### Create a half-reaction when reactant and product are known.

Complete the following half-reaction:  $\text{N}_2\text{H}_4 \longrightarrow \text{NO}_3^-$

- |    |  |  |
|----|--|--|
| 1. | Balance elements other than O and H      | $\text{N}_2\text{H}_4 \longrightarrow 2\text{NO}_3^-$  |
| 2. | Balance O by adding $\text{H}_2\text{O}$ | $\text{N}_2\text{H}_4 + 6\text{H}_2\text{O} \longrightarrow 2\text{NO}_3^-$                        |
| 3. | Balance H by adding $\text{H}^+$         | $\text{N}_2\text{H}_4 + 6\text{H}_2\text{O} \longrightarrow 2\text{NO}_3^- + 12\text{H}^+$         |
| 4. | Balance charge by adding $e^-$           | $\text{N}_2\text{H}_4 + 6\text{H}_2\text{O} \longrightarrow 2\text{NO}_3^- + 12\text{H}^+ + 10e^-$ |

## 9.3 Reactivity



**Standard conditions ( $\ominus$ )** all dissolved particles have  $[\dots] = 1.00 \text{ mol dm}^{-3}$ ,  
 $p = 100 \text{ kPa}$  and  $T = 298 \text{ K}$ .

**Standard electrode potential  $E_{\text{ox}}^{\ominus}$  or  $E_{\text{red}}^{\ominus}$**  is a measure of the tendency of a substance to oxidise or reduce.

In DB24, all reactions are written in terms of reduction; so the greater the  $E^{\ominus}$  value, the greater the ability to undergo reduction (and be an oxidizing agent). The  $E^{\ominus}$  values from DB24 are only valid under standard conditions. When the conditions change, so do the  $E^{\ominus}$  values.



**Standard electrode potential difference  $E^{\ominus}$**  difference between  $E_{\text{ox}}^{\ominus}$  and  $E_{\text{red}}^{\ominus}$

$$\begin{aligned} E^{\ominus} &= E^{\ominus}_{\text{(reduction)}} && -E^{\ominus}_{\text{(oxidation)}} \\ &= E^{\ominus}_{\text{(oxidised species)}} && -E^{\ominus}_{\text{(reduced species)}} \end{aligned}$$

When we calculate  $E^{\ominus}$ , we always do  $E_{\text{red}}^{\ominus} - E_{\text{ox}}^{\ominus}$ . This chapter isn't called red—ox for nothing ;-)

### Activity series of metals

The activity series ranks metals according to their reduction potential. Noble metals resist oxidation, while base metals readily oxidise. (A base-metal is the opposite of a noble metal, it is not a base). So Au resists oxidation, while Li promotes oxidation.

The complete activity series is shown in DB 25. Note the position of H: metals below H (such as Cu) do not oxidise in an acidic solution.

Li metal will react with other metal cations, since it is such a strong reducing agent. The more (re)active metal will donate  $e^-$  to the lesser active metal cation.

increasing activity

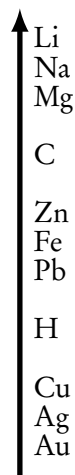

**Determine the order of activity from a set of reactions.**

What is the correct order of reactivity of the metals X, Y and Z based on the following equations?

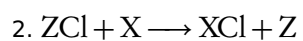
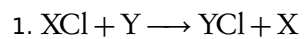

- |    |   |  |
|----|---|--|
| 1. | The more (re)active metal donates $e^-$ . | 1. Y donates electrons, so $\text{Y} > \text{X}$<br>2. X donates electrons, so $\text{X} > \text{Z}$ |
| 2. | Combine the activities in an ordered list | Y is more reactive than X is more reactive than Z  |

## 9.4 Electrochemical cells



**Voltaic cell** converts chemical energy from spontaneous chemical reactions to electrical energy.

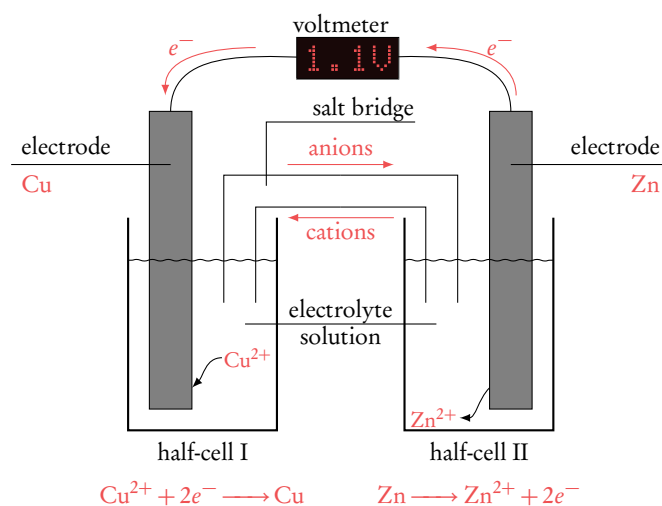

**Half-cell** consists of an electrode in contact with an *electrolyte*: an aqueous solution which contains ions. A half-cell *physically* separates the red. & ox. half-reactions, and the electrons flow through the external circuit with a certain potential difference (measured in volts).

**Cell diagram convention** a shorthand notation for a voltaic cell, showing the substances of the different components.

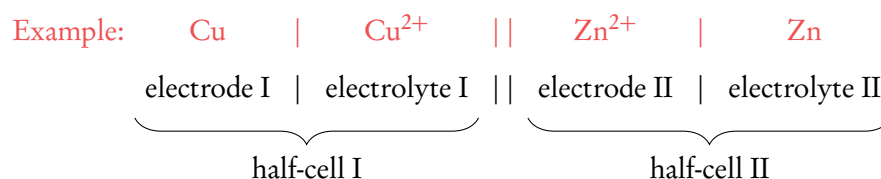

**Salt Bridge** contains an aqueous solution of ions that move across the salt bridge to neutralize the build up of charge in both half-cells to maintain the potential difference.

To find out in which direction anions and cations flow through the salt bridge, first determine the direction of the flow of electrons (using An OIL RIG Cat).

- Cations will go in the same direction as the electrons, to neutralize the charge. So from anode to cathode through the salt bridge.
- Anions will go in the opposite direction as the electrons, to neutralize the charge. So from cathode to anode through the salt bridge.

### AN OIL RIG CAT

#### ANode

Oxidation

Is

Loss of electrons,

Reduction

Is

Gain of electrons

CAThode.



**Electrolytic cell** converts electrical energy to chemical energy, bringing about non-spontaneous chemical reactions.

Since the reaction is non-spontaneous, the electrolytic cell does not need to be physically separated into half-cells, but it may. An electrolytic cell needs a power source, indicated with two lines: the longer is the positive terminal.

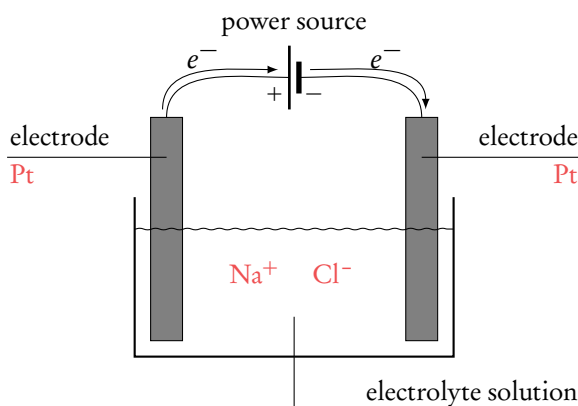

Examples of chemically inert electrodes (conductive substances that do not react) are Pt & C. They can be used in both voltaic and electrolytic cells.

### Voltaic cell and electrolytic cells compared

**AN OIL RIG CAT** reminds us that *oxidation occurs at the anode*, and *reduction occurs at the cathode*. But while oxidation *always* occurs at the anode, whether the electrode is + or - depends on whether we are dealing with a voltaic cell or an electrolytic cell. Taking the voltaic cell as the standard cell, or the one you learned about first, the anode is - just like anions have negative charge. In the electrolytic cell the reverse holds.

		voltaic cell	electrolytic cell
<b>ANode</b>	Oxidation occurs here	- electrode	+ electrode
<b>CAThode</b>	Reduction occurs here	+ electrode	- electrode

**In a voltaic cell:** chemical energy is converted to electrical energy. The reaction is spontaneous,  $E^\ominus$  is positive and the value = the voltage of the voltaic cell (battery).

**In an electrolytic cell:** electrical energy is converted to chemical energy. The reaction is not spontaneous,  $E^\ominus$  is negative and the value = the minimum voltage of the power source that is required to start the reaction.

## 9.5 The Winkler method and the BOD



**Winkler method** two sequential titrations that are performed on surface water to measure the initial amount of dissolved oxygen, and the amount after some pre-defined time to determine the BOD.

**Biochemical Oxygen Demand (BOD)** the amount of oxygen used to decompose organic matter in a sample of water over a specified time period.

If there is much organic matter (bad), much oxygen will be used up by bacteria during decomposition. And if there is little dissolved oxygen to begin with (bad), aquatic life will struggle to survive.

**Thermal Pollution:** water used in cooling engines in factories tend to be released into a water system, which decreases the dissolved oxygen content.

**Organic Matter:** a greater amount of organic matter in water means more micro-organisms will be present, thus decreasing the dissolved oxygen content. This usually occurs due to *eutrophication*: the excess use of fertilizers and detergents increases the amount of 'food' for bacteria and algae, increasing the BOD.

The Winkler determination of BOD is based on a sequence of redox reactions. The mole ratio between  $\text{O}_2(\text{aq}) = \text{dissolved oxygen (analyte)} : \text{S}_2\text{O}_3^{2-} (\text{titrant}) = 1:4$ .



# ORGANIC CHEMISTRY

10

## 10.1 Fundamentals of organic chemistry



**Empirical formula** shows the simplest whole number ratio of atoms in a compound.

**Molecular formula** shows the actual number of atoms in a molecule.

**Structural formula** shows the bonds between atoms, that form a molecule. It can be shown in full, condensed and skeletal form.

full	structural formulas condensed	skeletal	molecular formula	empirical formula
$\begin{array}{c} \text{H} & \text{H} & \text{H} \\   &   &   \\ \text{H}-\text{C}-\text{C}-\text{C}-\text{H} \\   &   &   \\ \text{H} & \text{H} & \text{H} \end{array}$	$\text{CH}_3\text{CH}_2\text{CH}_3$		$\text{C}_3\text{H}_8$	$\text{C}_3\text{H}_8$
$\begin{array}{c} \text{H} & \text{H} \\   &   \\ \text{H}-\text{C}-\text{C}-\text{OH} \\   &   \\ \text{H} & \text{OH} \end{array}$	$\text{CH}_3\text{CH}(\text{OH})_2$		$\text{C}_2\text{H}_6\text{O}_2$	$\text{CH}_3\text{O}$
$\begin{array}{c} \text{H} & \text{H} & \text{H} & \text{H} \\   &   &   &   \\ \text{H}-\text{C}-\text{C}=\text{C}-\text{C}-\text{H} \\   & & &   \\ \text{H} & & & \text{H} \end{array}$	$\text{CH}_3\text{CHCHCH}_3$		$\text{C}_4\text{H}_8$	$\text{CH}_2$

A note on **skeletal structures**: the C-atoms are not explicitly drawn, but a C-atom with the correct number of H-atoms is implied at the start/end of a line, and where lines intersect.

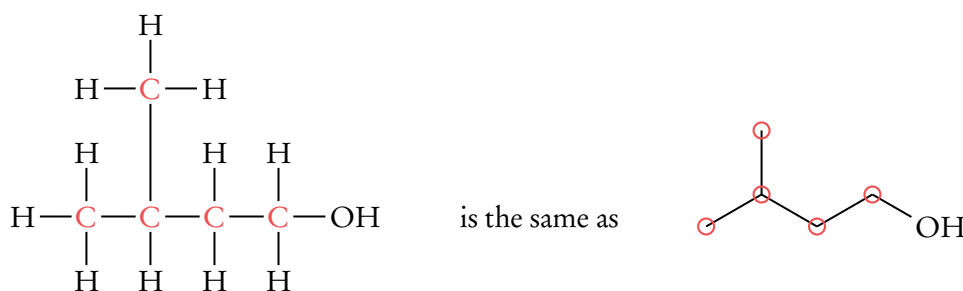



**Homologous series** successive members differ from each other by  $-\text{CH}_2-$ .

### alkane homologous series

name	structure	BP
methane	$\text{CH}_4$	$-162^\circ\text{C}$
ethane	$\text{CH}_3\text{CH}_3$	$-89^\circ\text{C}$
propane	$\text{CH}_3\text{CH}_2\text{CH}_3$	$-42^\circ\text{C}$
butane	$\text{CH}_3\text{CH}_2\text{CH}_2\text{CH}_3$	$0^\circ\text{C}$
pentane	$\text{CH}_3\text{CH}_2\text{CH}_2\text{CH}_2\text{CH}_3$	$36^\circ\text{C}$

### alcohol homologous series

name	structure	BP
methanol	$\text{CH}_3\text{OH}$	$64^\circ\text{C}$
ethanol	$\text{CH}_3\text{CH}_2\text{OH}$	$78^\circ\text{C}$
propan-1-ol	$\text{CH}_3\text{CH}_2\text{CH}_2\text{OH}$	$98^\circ\text{C}$
butan-1-ol	$\text{CH}_3\text{CH}_2\text{CH}_2\text{CH}_2\text{OH}$	$118^\circ\text{C}$
pentan-1-ol	$\text{CH}_3\text{CH}_2\text{CH}_2\text{CH}_2\text{CH}_2\text{OH}$	$138^\circ\text{C}$

Members of a homologous series have *similar chemical properties* (since they share the same functional group) and they show a *gradual change in physical properties* (for example their melting-/boiling points increase as a result of increasingly stronger London dispersion forces).

## 10.1.1 Classification of hydrocarbons



**Hydrocarbons** are compounds containing only hydrogen and carbon atoms.

**Saturated hydrocarbons**  
contain only C—C (alkane)

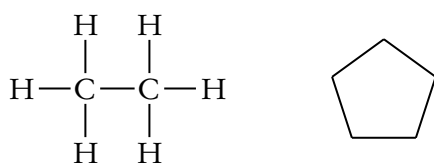

**Unsaturated hydrocarbons**  
contains C=C (alkene) or C≡C (alkyne)

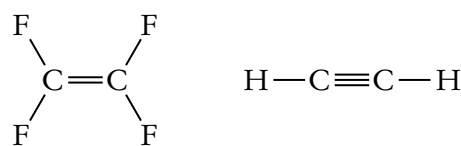

**Aliphatic compounds**  
compounds without benzene rings

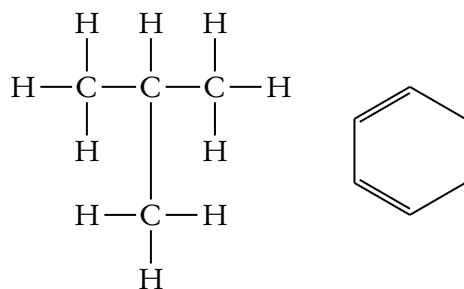

**Aromatic compounds**  
compounds with at least one benzene ring

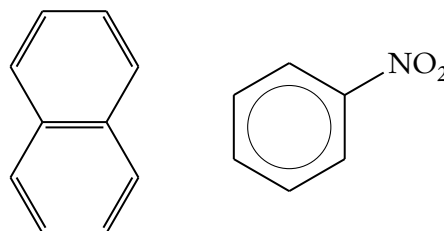

### Number of C neighbours



Alcohols, halogenoalkanes, amines and carbocations can be primary ( $1^\circ$ ), secondary ( $2^\circ$ ) or tertiary ( $3^\circ$ ). The atom of interest is the C atom that is bonded to  $-\text{OH}$  or  $-\text{X}$  or that carries the positive charge. For amines it is different, the atom of interest is the N atom.

	alcohol	halogenoalkane	amine	carbocation
primary ( $1^\circ$ )	$\begin{array}{c} \text{H} \\   \\ \text{CH}_3-\text{C}-\text{OH} \\   \\ \text{H} \end{array}$	$\begin{array}{c} \text{H} \\   \\ \text{CH}_3-\text{C}-\text{X} \\   \\ \text{H} \end{array}$	$\begin{array}{c} \text{CH}_3-\text{N}-\text{H} \\   \\ \text{H} \end{array}$	$\begin{array}{c} \text{CH}_3-\text{C}^+-\text{H} \\   \\ \text{H} \end{array}$
secondary ( $2^\circ$ )	$\begin{array}{c} \text{H} \\   \\ \text{CH}_3-\text{C}-\text{OH} \\   \\ \text{CH}_3 \end{array}$	$\begin{array}{c} \text{H} \\   \\ \text{CH}_3-\text{C}-\text{X} \\   \\ \text{CH}_3 \end{array}$	$\begin{array}{c} \text{CH}_3-\text{N}-\text{H} \\   \\ \text{CH}_3 \end{array}$	$\begin{array}{c} \text{CH}_3-\text{C}^+-\text{H} \\   \\ \text{CH}_3 \end{array}$
tertiary ( $3^\circ$ )	$\begin{array}{c} \text{CH}_3 \\   \\ \text{CH}_3-\text{C}-\text{OH} \\   \\ \text{CH}_3 \end{array}$	$\begin{array}{c} \text{CH}_3 \\   \\ \text{CH}_3-\text{C}-\text{X} \\   \\ \text{CH}_3 \end{array}$	$\begin{array}{c} \text{CH}_3-\text{N}-\text{CH}_3 \\   \\ \text{CH}_3 \end{array}$	$\begin{array}{c} \text{CH}_3-\text{C}^+-\text{CH}_3 \\   \\ \text{CH}_3 \end{array}$

### 10.1.2 Functional groups



**Chemical class** a family of compounds that share the same functional group.

**Functional group** gives distinct chemical properties to a compounds, the reactive part of the molecule.

Sometimes the class of compounds has a different name as the functional group. The functional group names have come up quite often on IB-exams, be sure you know their names.

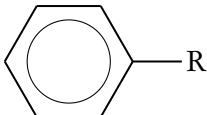
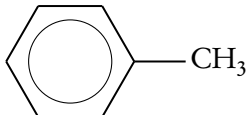
chemical class	functional group	contains	root	examples
alkane	alkyl	C—C only	alkane	$\text{CH}_3-\text{CH}_2-\text{CH}_3$
alkene	alkenyl	C=C	alkene	$\text{CH}_2=\text{CH}-\text{CH}_3$
alkyne	alkynyl	$\text{C}\equiv\text{C}$	alkyne	$\text{H}-\text{C}\equiv\text{C}-\text{H}$
arene (benzene derivative)	phenyl			

chemical class	functional group	condensed	full structural	suffix/prefix	examples
carboxylic acid	carboxyl	—COOH	$\begin{array}{c} \text{O} \\ \parallel \\ \text{—C} \\ \backslash \\ \text{OH} \end{array}$	-oic acid	$\text{CH}_3\text{—}\begin{array}{c} \text{O} \\ \parallel \\ \text{C} \\ \backslash \\ \text{OH} \end{array}$
aldehyde	aldehyde	—CHO	$\begin{array}{c} \text{O} \\ \parallel \\ \text{—C} \\ \backslash \\ \text{H} \end{array}$	-al	$\text{C}_6\text{H}_5\text{—}\begin{array}{c} \text{O} \\ \parallel \\ \text{C} \\ \backslash \\ \text{H} \end{array}$
ketone	carbonyl	—CO—	$\begin{array}{c} \text{O} \\ \parallel \\ \text{C} \\ / \quad \backslash \\ \text{C} \quad \quad \text{C} \end{array}$	-one	$\text{H}_3\text{C—}\begin{array}{c} \text{O} \\ \parallel \\ \text{C} \\ \backslash \\ \text{CH}_3 \end{array}$
alcohol	hydroxyl	—OH		-ol	CH <sub>3</sub> —OH
amine	amine	—N(H,R) <sub>2</sub>		-amine	H <sub>2</sub> N—CH <sub>3</sub>
nitrile	nitrile	—CN	—C≡N		N≡C—CH <sub>3</sub>
ether	alkoxy	—O—	C—O—C	alkoxy-	CH <sub>3</sub> —O—CH <sub>3</sub>
halogen		—X		halogeno-	CH <sub>3</sub> —Br
side-chain		—CH <sub>3</sub> , —CH <sub>2</sub> CH <sub>3</sub> ,...		alkyl-	$\text{CH}_3\text{—}\begin{array}{c} \text{CH} \\   \\ \text{CH}_3 \end{array}\text{—CH}_3$
ester	ester	—COO—	$\begin{array}{c} \text{O} \\ \parallel \\ \text{—C—O—C} \end{array}$		$\text{CH}_3\text{—CH}_2\text{—O—}\begin{array}{c} \text{O} \\ \parallel \\ \text{C} \\ \backslash \\ \text{CH}_3 \end{array}$
amide	carboxamide	—CON(H,R) <sub>2</sub>	$\begin{array}{c} \text{O} \\ \parallel \\ \text{—C—N—} \\   \\ \text{H} \end{array}$		$\text{H—}\begin{array}{c} \text{O} \\ \parallel \\ \text{N—C—CH}_3 \\   \\ \text{H} \end{array}$

## 10.1.3 Nomenclature

## Naming organic molecules

Determine the name of the following compound:

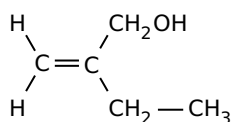

1. Determine the longest uninterrupted chain, including the functional group(s)

**alk:** meth-, eth-, prop-, but-, pent-, hex-

**types:** -ane, -ene, -yne

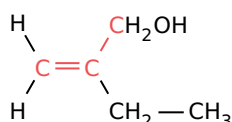

**root:** propene  
the longest chain with the —OH and C=C included is three, not four.

2. Determine the functional groups

**suffix:** -oic acid, -al, -one, -ol, -amine

**prefix:** halogeno-, alkoxy-, alkyl-

**multiple:** di-, tri-, tetra-... etc

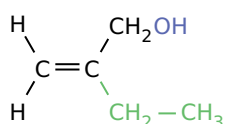

**suffix:** -ol  
**prefix:** -ethyl

3. Number as low as possible:

1 C-atom with the functional group

2 double and triple bonds

3 other

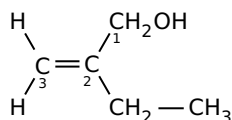

start counting so that the functional group —OH is lowest.

4. Write full name: **prefix****root****suffix**

1 dash ( - ) between numbers and letters

2 comma ( , ) between numbers

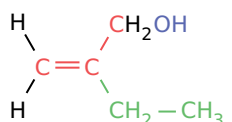

2-ethylprop-2-ene-1-ol

1.	<b>root:</b> ethane	<b>root:</b> butyne	<b>root:</b> ethene
2.	<b>suffix:</b> -oic acid <b>prefix:</b> trichloro-	<b>suffix:</b> -dial <b>prefix:</b> —	<b>suffix:</b> — <b>prefix:</b> propoxy-
3.			
4.	2,2,2-trichloroethanoic acid	but-2-yne-1,4-dial	1-propoxyethene

### 10.1.4 Resonance structure of benzene

The simplest aromatic hydrocarbon is benzene,  $C_6H_6$ .

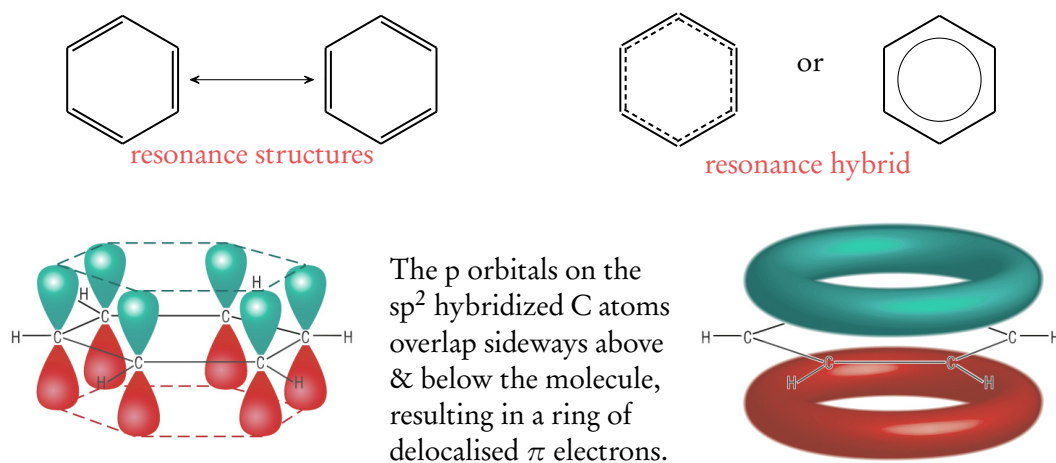

The six  $C\equiv C$  are each equally strong and long (bond order is 1.5), instead of having three  $C-C$  and three  $C=C$  bonds (of bond orders 1 and 2). The strength and length of the  $C\equiv C$  bonds are somewhere between that of  $C-C$  and  $C=C$ .

**Chemical proof:** while regular alkenes readily undergo addition reactions, benzene resists addition and instead undergoes substitution reactions.

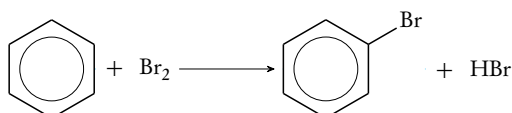

**Physical proof:** the following table shows measured bond strengths and lengths.

	bond strength in $\text{kJ mol}^{-1}$	bond length in nm
$C-C$	346	0.154
$C=C$	614	0.134
$C\equiv C$	507	0.140

## 10.2 Structural isomers



**Structural isomers** same molecular formula, different structural formulas

There are three sub-categories of structural isomers, that correspond to three strategies when drawing structural isomers:

Generally speaking, branched isomers exist when molecules have 4 or more C-atoms.

**1. chain isomers:** arise because of the possibility of branching in carbon chains.

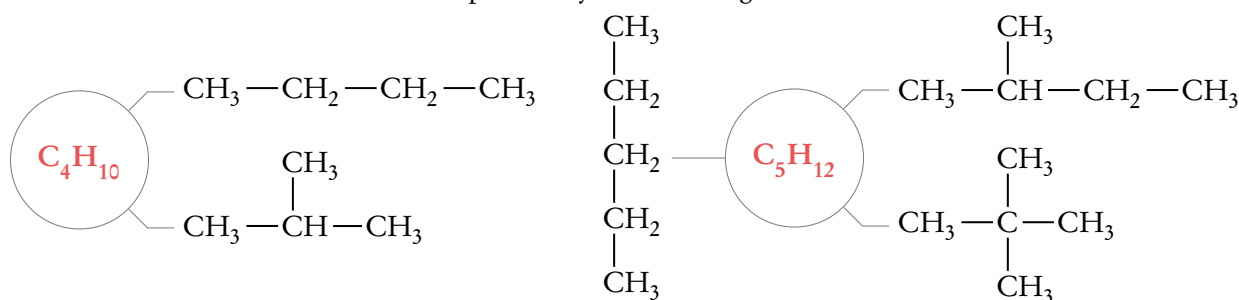

**2. positional isomers:** the carbon skeleton remains unchanged, but groups have different positions.

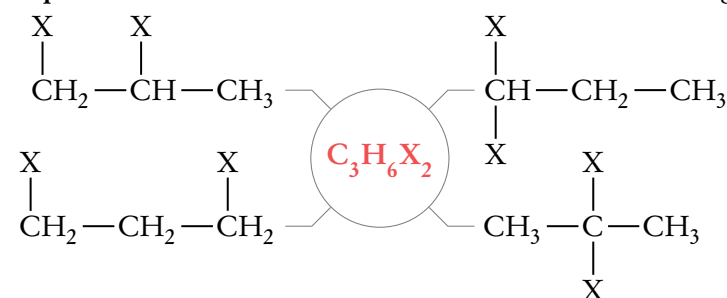

**3. functional group isomers:** the isomers contain different functional groups.

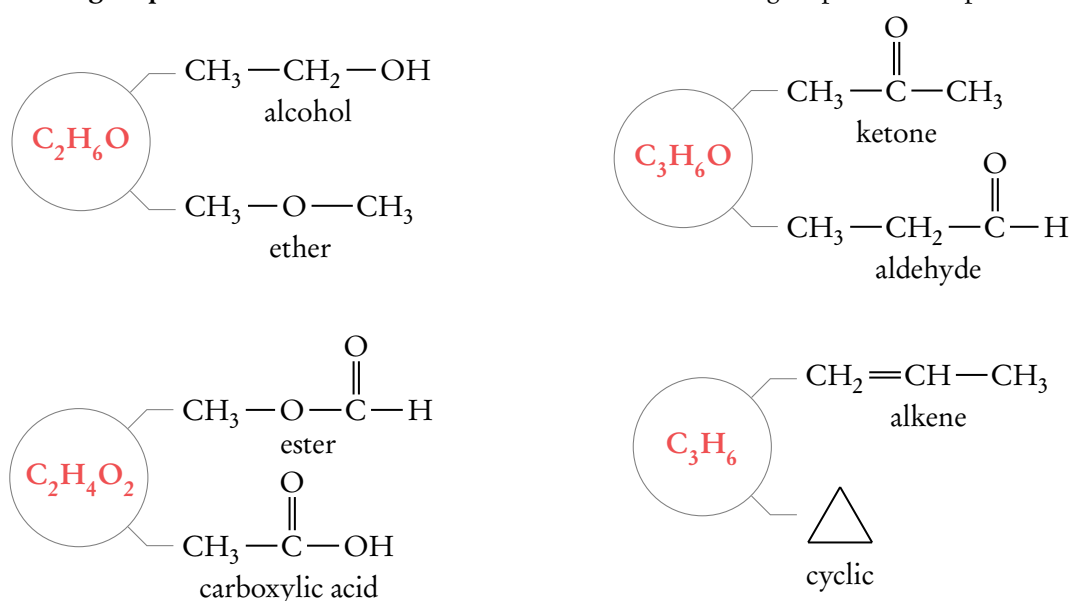

When you are asked to draw the structural isomers from a given molecular formula, think about *all three* types. Ask yourself: Can you branch the carbon chain? Can you move a group around on that chain? Is it possible to change the functional group?

### Finding structural isomers

Find all the structural isomers that exist of  $C_4H_{10}O$ .

**1. Branches:** Is branching a possibility?

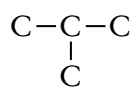
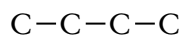

**2. Positions:** Draw any one isomer. If any, can the position of the functional group be drawn at a different position?

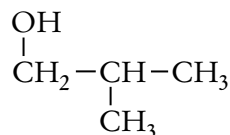
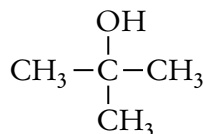
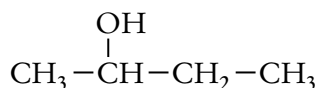
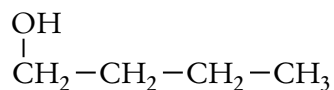

**3. Functional group:** Can you draw another functional group instead of the previous? Also change the position of this group.

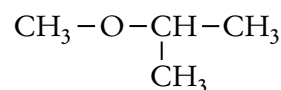
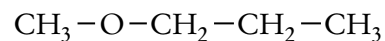
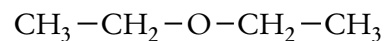



## 10.3 Reactions

### 10.3.1 Combustion

Combustion is an exothermic reaction between a fuel and oxygen. Based on the elemental composition of a fuel, we can predict which products form after combustion.

element in fuel	combustion product	averse effects
H	H <sub>2</sub> O	—
C	CO <sub>2</sub> (complete)	greenhouse gas
	CO (incomplete)	poisonous, irreversibly binds to haemoglobin
	C (incomplete)	irritation to the repository tract
S	SO <sub>2</sub>	acid deposition
N	NO	acid deposition

Dependent if oxygen is in excess or limited, *complete combustion* ( $\rightarrow$  CO<sub>2</sub>) or *incomplete combustion* ( $\rightarrow$  CO and/or C) occurs.

### 10.3.2 Substitution



**Free radical substitution reaction** a halogen atom ( $-X$ ) replaces a hydrogen atom ( $-H$ ) in *alkanes*, under the influence of light.

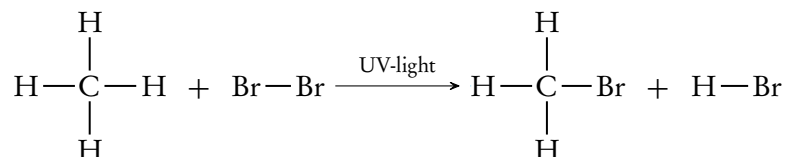

Alkanes have strong non-polar C—C and C—H bonds, hence alkanes are relatively inert (unreactive). Under the influence of (UV-)light, halogens (X<sub>2</sub>) can form very reactive radicals that can replace H-atoms in alkanes.

**Nucleophilic substitution reaction** a 'stronger' nucleophile such as OH<sup>-</sup> replaces a 'weaker' nucleophile such as  $-X$

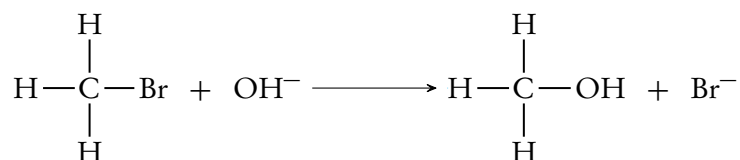

Halogenoalkanes are more reactive than alkanes since they possess polar bonds C—X. The C-atom can be 'attacked' by electron-rich nucleophiles. Moreover, C—X bonds are typically weaker than C—H bonds making  $-X$  easier to replace. Since halogenoalkanes are more reactive than alkanes, no light is required to initiate the reaction.

## 10.3.3 Addition



**Addition reaction** the  $\pi$  bond in *alkenes* or *alkynes* opens, and new bonds form to each of the two carbons around the original  $\pi$  bond.

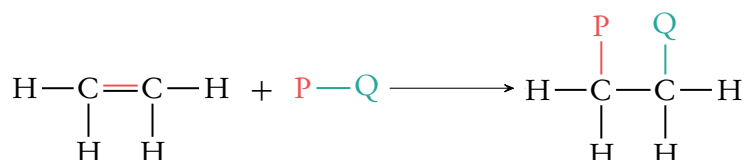

$\pi$  bonds are somewhat weaker than  $\sigma$  bonds, so alkenes and alkynes are more reactive than alkanes resulting in the fact that no light is needed for reaction. Alkenes and alkynes will undergo addition reactions instead of substitution.

## addition of example

**hydrogenation**  
→ alkane

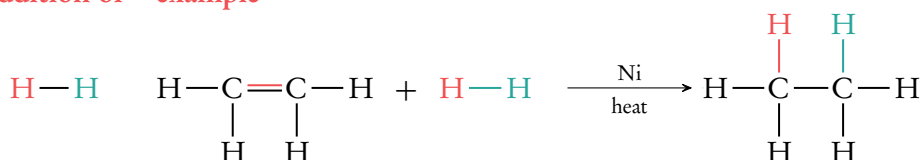

**halogenation**  
→ dihalogeno

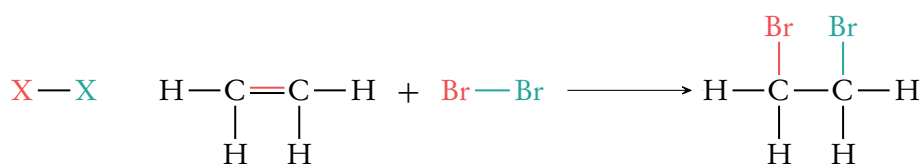

**halogenation**  
→ halogeno

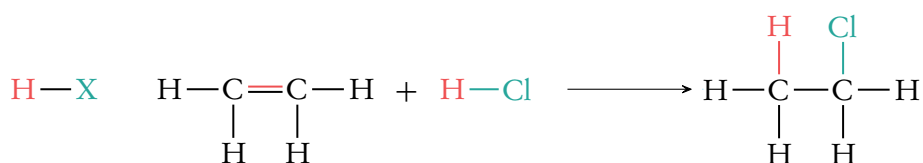

**hydration**  
→ alcohol

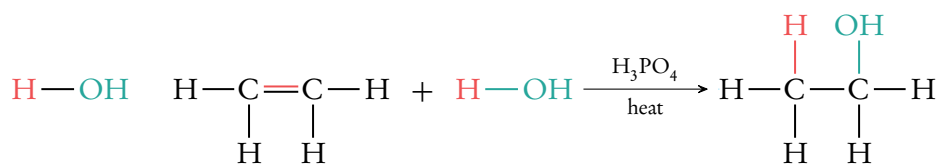

## Differentiate experimentally between alkanes and alkenes/alkynes

$\text{Br}_2$  has a distinct brown colour. By adding a drop to an excess alkane or alkene/alkyne, the brown colour completely disappears as  $\text{Br}_2$  is the limiting reactant:

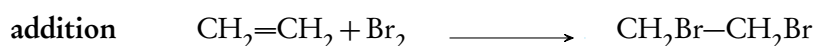

Performing the experiment in the dark however, prevents the substitution reaction from occurring: the  $\text{Br}_2$  would only decolorize if the addition reaction can occur, thus providing evidence for the presence of double bonds.

## Addition polymerization



**Polymer** a large molecule that forms by linking many monomers together.  
Synthetic plastics are an example of polymers.

**Addition polymer** the monomers react by breaking the double bond,  
linking on every second C atom.

The trick to drawing polymers is to draw 90° angles in the monomers:

in general:

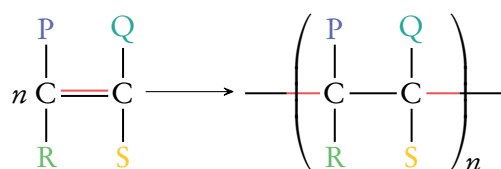

Example

polybut-2-ene:

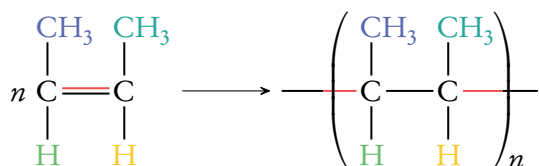

The repeating unit of an addition polymer always contains *two* C atoms, since it reflects the structure of the monomer. Reasoning backwards starting from the polymer, it is between these two C atoms that the monomer had the double bond.

### 10.3.4 Condensation / esterification reaction

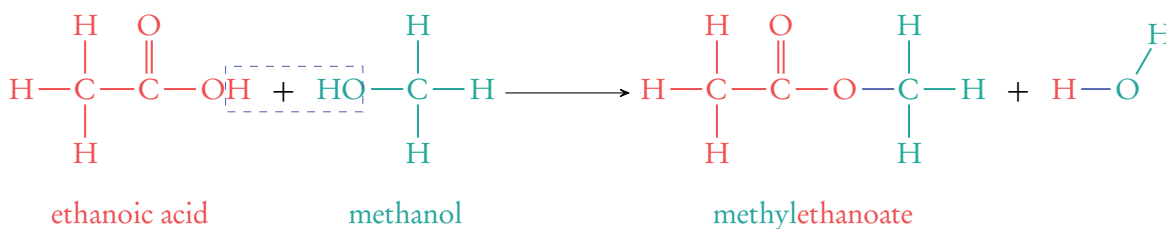
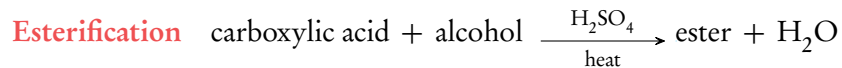

Naming esters is different from naming other organic compounds. The general name of esters is alkylalkanoate, where the alkyl part of the name is derived from the alcohol parent and alkanoate is derived from the carboxylic acid parent molecule.

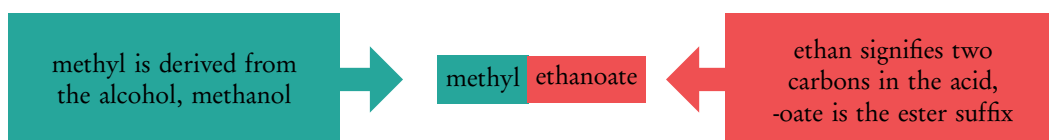

Remember that “alk” in both parts of the name should be replaced by the numeric prefix meth-, eth-... to signify the number of C atoms.





# MEASUREMENT AND DATA PROCESSING



**Qualitative data** refers to all non-numerical information that can be obtained from observations rather than a measurement. Used to identify: which compound?

**Quantitative data** refers to numerical information obtained from measurements, always associated with systematic and random error/uncertainty. Used to identify: how much compound?

**Systematic error** refers to flaws in experimental design and machine calibration that lead to an error, which is deviated in a particular direction.

**Random Error** are statistical fluctuations (in either direction) in the measured data. This can be caused by:

1. Readability or precision limitations of the measuring equipment
2. Uncontrollable changes in the surroundings between trials, such as temperature variations, air currents, ...

**Accuracy** refers to how close trials are to a standard/known literature value.  
→ High systematic error leads to low accuracy.

**Precision** refers to how close trials are to each other.  
→ High random error leads to low precision.

To decide if an error is systematic or random ask yourself: would repeating the experiment (partially) remove the error?

For example, the boiling point of water at sea level is measured several times. Two different brands of digital temperature probes are used. The temperature readings from brand 1 give have a larger random error than brand 2. To reduce the effects of random error we can increase the number of trials.

	brand 1	brand 2
Trial 1	102.5 °C	96.5 °C
Trial 2	101.5 °C	96.7 °C
Trial 3	97.5 °C	96.6 °C
Average	100.5 °C	96.6 °C

Brand 2 suffers from a large systematic error, but it is very precise. To reduce the systematic error, the temperature probe could be re-calibrated.

## 11.1 Graphical Techniques



**Sketched graphs** have labelled but unscaled axes, and are used to show *trends*, such as variables that are (inversely) proportional.

**Drawn graphs** have labelled and scaled axes, and are used in quantitative measurements.

A graph helps in understanding a trend or mathematical relationship in experimental data. It shows the effect that changing an independent variable ( $x$ -axis) has on the dependent variable ( $y$ -axis). The value of the dependent variable *depends* on the value of the independent variable.

### Line of best fit

All experimental data is prone to some form of error. A line of best fit shows the appropriate relationship between  $x$  and  $y$ , taking the variation of individual measurements due to error into account. The line of best fit does not (necessarily) go through all the data points. But it is always a continuous line without sharp “bends” that passes as near to as many points as possible. Lines of best fit can be drawn for any mathematical relationship: linear, quadratic, exponential, etc...

When asked to draw a line of best fit: use a pencil first, and consider if it should pass the origin or not.

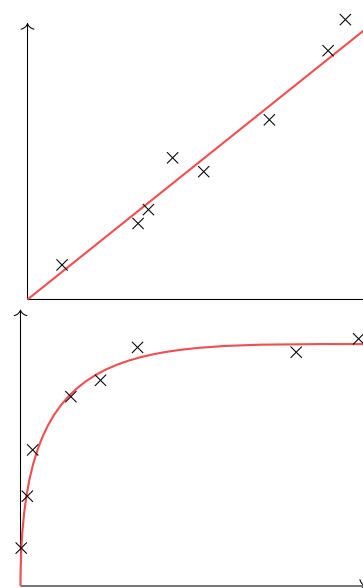

### Linear graphs

When the dependent variable is proportional to the independent variable, it is called a linear function (i.e. a straight line). The general formula is:  $y = mx + c$

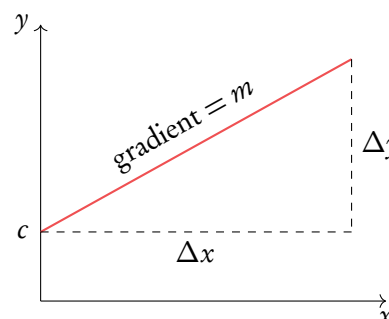

The gradient  $m$  (slope) of the line expresses the proportionality *factor*:

- when  $m = 2$  then  $y$  increases by 2 everytime  $x$  increases by 1
- when  $m = 0.43$  then  $y$  increases by 0.43 everytime  $x$  increases by 1



The value of the gradient can be calculated by:  $m = \frac{\Delta y}{\Delta x}$ .

When determining the gradient from a given graph, oftentimes *after* drawing the line of best fit, the triangle used to calculate the gradient should be as large as possible. Also use your ruler, and take care to read the values from the graph as precisely as you can!

When  $c = 0$ , the graph intersects at the origin and  $y$  is *directly* proportional to  $x$ .

## Graphical techniques

**The  $y$ -intercept:** the initial or starting value, when  $x = 0$ .

**The gradient** of a curve at a certain point  $\left(m = \frac{\Delta y}{\Delta x}\right)$ .

Since  $y/x$ , the units of the gradient will be the units of  $y$  divided by the units of  $x$ .

**The area** under the curve between two points (area =  $\Delta y \cdot \Delta x$ ).

Since  $y \cdot x$ , the units of the area will be the units of  $y$  times the units of  $x$ .

**Interpolation:** a value on a graph between measurements.

**Extrapolation:** a value on a graph outside the measurements, assuming that the graph continues the trend.

Example.

When a graph is not linear, the gradient changes continuously. The gradient at a certain point can be determined by first drawing the tangent, and then the gradient  $m$  can be determined from a large  $\Delta y$  vs  $\Delta x$  triangle.

**Determine the rate of the reaction at  $t = 10$  s from the given graph, and derive the units for the rate of reaction.**

The rate of reaction is the change in concentration per unit of time, or the gradient in the concentration vs time graph.

Start by drawing the tangent line at  $t = 10$  s using a ruler.

Next, find two convenient points on the tangent as far away from each other to calculate the gradient

$$m = \frac{\Delta y}{\Delta x} = \frac{0.30 - 0.10}{25 - 0} = 8.0 \times 10^{-3}$$

To determine the correct units, simply put the units into the formula instead of the values:

$$m = \frac{\Delta y}{\Delta x} = \frac{\text{mol dm}^{-3}}{\text{s}} = \text{mol dm}^{-3} \text{ s}^{-1}.$$

The rate of the reaction at  $t = 10$  s is  $8.0 \times 10^{-3} \text{ mol dm}^{-3} \text{ s}^{-1}$ .

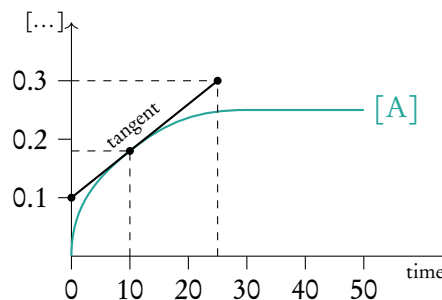

## Inversely proportional

A typical question that involves an inversely proportional relationship is that between the pressure and the volume of a gas, when the mass and temperature are kept constant.

From chapter 1, remember that the ideal gas law can be written as:  $nR = \frac{p_1 V_1}{T_1} = \frac{p_2 V_2}{T_2}$

$$\text{So at constant } T: \frac{p_1 V_1}{T_1} = \frac{p_2 V_2}{T_2} = p_1 V_1 = p_2 V_2$$

Since  $p_1 V_1 = p_2 V_2$ , when the pressure is doubled: the volume halves (and vice versa).

This is called inversely proportional, and it produces the graph you see on the right.

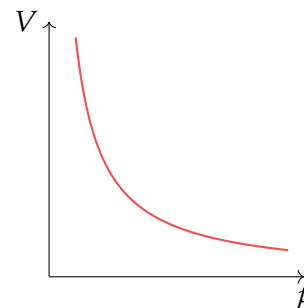

Such an inversely proportional function can be displayed as a linear function by changing one variable to its inverse.

For example: change the  $p$ -axis to  $\frac{1}{p}$ .

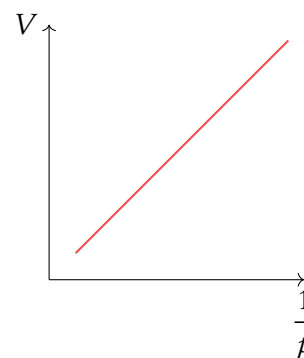

## 11.2 Spectroscopic identification

From personal experience of the authors, we can say that it is often difficult to identify the compounds that we create in the lab, as well as their purity. Advanced spectroscopic techniques help us identify the compounds we create.

Spectroscopic methods can give insight in the arrangement of atoms that form a molecule. But often there is no certain definitive answer, and we have to understand that each single technique has strengths and weaknesses.

Oftentimes, chemists combine spectroscopic methods to take advantage of the strengths and weaknesses of each individual method.

### List of spectroscopic methods



The operating principles are not required for any of these methods, you will only be tested on knowing how and what information to gather.

**Index Hydrogen Deficiency (IHD)** also known as the degree of unsaturation, is used to determine the number of  $H_2$  molecules required to convert any molecule to one that is *saturated* and *non-cyclic*.

**Mass spectrometry** measures the mass of the molecule, and the masses of the fragments that form from the molecule.

**Infrared (IR) spectroscopy** identify the type of bonds and functional groups present in a molecule.

**Proton Nuclear Magnetic Resonance ( $^1H$ -NMR) spectroscopy** identifies for hydrogen atoms: 1. their chemical environment, 2. the ratio between the number of hydrogen atoms in the same environment, and 3. the number of neighbouring hydrogen atoms in a molecule.

**X-Ray Diffraction** identify the lengths and angles of bonds in any type of substance (metal, ionic and molecular).

## IHD - index of hydrogen deficiency

The value of IHD = number of rings + number of  $\pi$  bonds

It is equal to the number of  $H_2$  molecules required to convert any molecule to a *saturated* and *non-cyclic* compound. This means that a saturated and non-cyclic compound would have an IHD value of 0.

The index of hydrogen deficiency is given by:

$$\text{IHD} = \frac{2 + 2 \cdot C + N - H - X}{2}$$

$C$  = number of carbon atoms  
 $H$  = number of hydrogen atoms  
 $X$  = number of halogen atoms  
 $N$  = number of nitrogen atoms

When a structural formula of a molecule is given, the IHD is easily determined, namely by the counting the number of  $\pi$  bonds and rings.

Example.

Benzene has an IHD = 4, because it has 3  $\pi$  bonds and one ring. On the exam, students often forget to add one to the IHD for each ring.

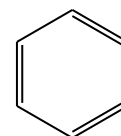

When the molecular formula is given the IHD must be determined by the above given formula. A quick way to remember the formula is by drawing the following structure:

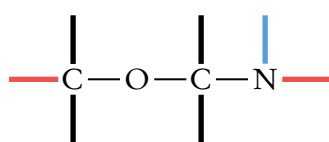

$$\frac{+2 + 2 \cdot C + N - H - X}{2}$$

- A saturated non-cyclic molecule starts and ends with a hydrogen, so **+2**.
- Any carbon atom requires 2 hydrogen atoms each, so **+2·C**.
- Any nitrogen atom requires 2 hydrogen atoms each, so **+N**.
- The number of oxygen atoms have no influence on the IHD.

Furthermore, since the IHD is about hydrogen *deficiency*, we subtract 1 for every hydrogen we do have. And since halogens replace a hydrogen, we also deduct one for those.

And finally, since the IHD counts the number of  $H_2$  molecules that would be required, we have to **divide by 2**.

